



Gelu PDU

Smart PDU User Manual

Firmware V1.2.0

User Manual

Safety Use Precautions

Please read this manual carefully before installing or using this product.

Warning! Use this product within the voltage and current range specified on the product nameplate. Otherwise, it may result in equipment damage, fire, electric shock or personal injury.

Warning! This product needs to be grounded reliably. Failure to connect this product to a protective earth ground may result in equipment damage, fire, electric shock or personal injury.

Warning! Do not open, modify or disassemble this product. Disconnect all input power before repairing this product, otherwise it may cause electric shock or casualties.

Warning! Please use this product indoors and in a dry environment. If it is not used in a dry environment, it may cause electric shock or casualties.

Warning! This product is only used to power IT equipment in line with UL 60950 GB / T 4943.1 or equivalent standard.

Warning! If this product is a model that requires assembly of its power cord or plug, all such assembly must be performed by a licensed electrician and the power cord or plug used must be suitably rated based on the product nameplate ratings and national and local electrical standards. Assembly by unlicensed electrician or failure to use suitably rated power cords or plugs may cause fire, electric shock, or casualties.

Warning! Do not use this product for intensive care equipment, fire or smoke alarm system, otherwise it may cause casualties.

The symbols and meanings indicated on this product:



Danger sign: Beware of electric shock!



Warning sign: Do not disassemble the machine without the original certified personnel!



Warning sign: This product needs to be reliably grounded!

Safety Operation

1. This product should be installed by an experienced licensed electrician.
2. Make sure to disconnect the power cord from the input power before installing the product or moving its physical location.
3. This product can be installed in an IT equipment rack for use. The metal casing of this product must be connected to the ground wire of the power cord. If there is a reserved grounding thread on the casing, the grounding point on the casing can be used to provide additional grounding protection for the product and the frame.
4. Check the branch circuit that supplies power to the product. Make sure that the phase, neutral, and ground terminals of the power cord are connected correctly. Be sure to protect the branch circuit socket with a fuse or circuit breaker of the appropriate rating.
5. If the product is a model with a socket on/off (Switched model), the outlet may be under power even if the outlet switch is off.

This document contains patent information that is protected by copyright, all rights reserved. No part of this document may be photocopied, reproduced, or translated to another language without the express prior written permission of GELU SYSTEMS INC.

© Copyright 2018 All third-party software and hardware mentioned in this manual by GELU SYSTEMS INC. are registered trademarks or trademarks of their respective owners and are the property of their respective owners.

FCC Information

This equipment has been tested and found to comply with the limits for a Class A digital device, pursuant to Part 15 of the FCC Rules. These limits are designed to provide reasonable protection against commercially installed equipment from harmful interference. If the product is used in a residential area without following the installation and use instructions of the manual, the RF energy generated and radiated may cause harmful interference to wireless communications.

GELU SYSTEMS INC. is not liable for product damage caused by accidents, disasters, misuse, abuse, unauthorized modification of products or other events that are not reasonably controlled by GELU Corporation, or product damage caused under abnormal working conditions.

警告! CAUTION! PRUDENCE!

- 为降低电击风险, 本品仅限室内及干燥环境使用。
To reduce the risk of shock, use in doors only in a dry location.
Pour réduire les risques de choc, utiliser sur les portes uniquement dans un endroit sec.
- 非专业人员请勿拆机。
Refer servicing to qualified personnel.
Faire appel à un personnel qualifié.
- 仅限在IT设备上使用, 且确保接地良好。
For use with IT equipment only. And make sure grounding connection.
Pour utilisation avec l'équipement informatique uniquement.
- 未使用产品时请保持所有输入电源断开。
Disconnect power before servicing. Remove all of powers from the unit.
Débranchez l'alimentation avant d'effectuer l'entretien Retirez toutes les puissances de l'équipement.



CONTENTS

Safety Use Precautions	1
Safety Operation	2
Product Overview	9
1. Function Introduction	10
1.1 Monitoring function	10
● Power Analysis	10
● Environmental Temperature and Humidity Measurement	10
1.2 Control Function	10
● Switch Control	10
● Switch Timing Setting	10
● Socket Group Definition	10
1.3 Alarm Function.....	11
● Alarm Level.....	11
● Alarm Setting.....	11
● Alarm Trigger.....	11
● Alarm Mode	11
1.4 History Record	11
1.5 Logging.....	11
1.6 User Management	11
1.7 System Upgrade	11
1.8 Multi-user System Management and Operation.....	12
1.9 Hardware Cascade	12
1.10 Dual NIC redundancy	12
2. Product Installation.....	13
2.1 Package Attachment	13
● 1U PDU Product	13
● 0U PDU Product	13
2.2 Installation	13
● Horizontal installation of 1U PDU products using L-shaped brackets.....	13
● Vertical installation of 1U PDU products using L-shaped brackets	14

- L-shaped bracket..... 14
 - Install the 0U PDU product vertically using a nylon washer. 15
 - Mount the 0U PDU product vertically using the Z-shaped bracket 16
 - Vertical installation of 0U PDU products using a straight bracket 17
 - Mount the 0U PDU product vertically using the side mount bracket..... 17
- 3.Product Use 18
 - 3.1 Start using 18
 - Power connection 18
 - Accessory Connection 19
 - Communication Connection..... 19
 - Metered LCD Modul Connection 19
 - Circuit Breaker..... 20
 - 3.2 Panel Instruction 21
 - 0U model with LCD control panel..... 21
 - 0U Model without LCD control panel 22
 - Interface for 1U/2U Model..... 22
 - TFT LCD Displayer and operation 23
 - Segment code LED Display 24
 - Reset/password and network address reset operation..... 24
 - 3.3 LCD interactive interface..... 24
 - Startup screen 24
 - First configuration 25
 - Display area/Main screen..... 26
 - Main Menu 27
 - Alerts Events..... 28
 - Monitoring parameter view 28
 - Outlet information and control 29
 - Setup configuration..... 31
 - Peripheral..... 33
 - Device Info 33
 - 3.4 Outlet..... 34

- 4. Web operation instruction..... 35
 - 4.1 Browser support 35
 - 4.2 log in 35
 - 4.3 Web exit..... 36
 - 4.4 Web interface description..... 36
 - 4.5 Navigation area (menu) 36
 - 4.6 Overview 38
 - Device running state..... 38
 - System information 39
 - Input Active Power historical curve..... 39
 - Line status 40
 - Sensor status 40
 - Network 41
 - 4.7 Power monitoring and setting 41
 - Inlet state and setting 41
 - Threshold Settings..... 44
 - Over-Current Protectors info 46
 - Outlets..... 48
 - 4.8 Peripherals monitoring and configuration 56
 - Sensors 56
 - 4.9 Configuration 58
 - System..... 58
 - Network 61
 - 4.10 User Management 64
 - Users 64
 - User preference..... 67
 - Change Password 67
 - 4.11 Maintenance 68
 - Ping 68
 - Upgrade Firmware..... 68
 - Backup/Restore 69

- History Data Files..... 71
- File..... 71
- View Event Log 71
- Restart 72

5. Using the Command Line Interface(CLI)..... 74

- 5.1 About the CLI 74
- 5.2 Logging in to CLI 74
- 5.3 about different CLI Modes and Prompts 76
- 5.4 Common command..... 76
 - Help 76
 - config..... 76
 - exit 76
 - show..... 77
 - Outlets..... 77
 - Ping 78
 - password 78
- 5.5 configuration command..... 78
 - apply/cancel 78
 - Reset 79
 - IPv4..... 79
 - PDU 81
 - Inlet 81
 - OCP..... 81
 - Outlet 81
 - External sensor 82

6. Using SNMP 83

- 6.1 Enabling and Configuring SNMP..... 83
- 6.2 Configuring SNMPv3 84
- 6.3 Configuring SNMP Trap 84
- 6.4 Download the MIB file 85

Appendix A Function list of series models 86

Appendix B CLI common command summary 90

Appendix C Specification 91

 C.1 Operating environment 91

 C.2 Measurement accuracy specification 91

 C.3 Port Pinouts 91

Document release history 93

Product Overview

Gelu Smart PDU is a rack-mounted network intelligent power monitoring device that provides module temperature and humidity monitoring, remote power switch, network management, smart meter and real-time energy consumption monitoring, emergency protection, intelligent control and other functional modules. For use in computer room, data center, laboratory, factory and other applications for remote power switch, energy-saving control, energy analysis, centralized management of electricity.

There are four series of Gelu Smart PDUs, Smart、Smart-POM、Switched、Switched-POM, among which:

Function	Smart	Smart-POM	Switched	Switched-POM
Input monitoring	●	●	●	●
Temperature and humidity monitoring	●	●	●	●
Threshold alarm	●	●	●	●
Output socket monitoring	-	●	-	●
Output socket control	-	-	●	●

Smart The PDU input electrical parameter values, ambient temperature and humidity, PDU status and settings can be easily viewed on the local panel of this model, and it can also be accessed through the network or serial port. The model also provides warnings about the input power status and environmental conditions. It provides various alarm modes such as SNMP Traps and Email for selection.

Smart-POM (Per Outlet Monitor) Based on the Smart model, the model adds electrical parameter monitoring for each output unit, including voltage, current, power, power factor, frequency, and energy consumption, and can set alarm thresholds and alarm notifications for these parameters.

Switched The model not only has the function of remotely obtaining input electrical parameters and environmental parameter data, but also can control the on-off state of the PDU output unit and set the on-off sequence separately or in batches.

Switched-POM The model has the monitoring and control functions of high-precision socket-level power control. On this basis, it also has the capability of remote access, input power monitoring and environmental parameter monitoring of Smart models.

1. Function Introduction

1.1 Monitoring function

- **Power Analysis**

This product can monitor the input power, and the POM model can also measure the energy of each output unit, including current, voltage, apparent power, active power, power factor, frequency and energy consumption. The energy metering accuracy reaches level 1 (error 1%). Detailed accuracy can be found in Appendix B.

- **Environmental Temperature and Humidity Measurement**

This product supports external sensor access to monitor the temperature and humidity environment of the cabinet or data center. The PDU supports two external temperature and humidity sensors for direct access. The display resolution of the sensor is 0.1, and the temperature accuracy is ± 0.5 degrees Celsius. The humidity accuracy is $\pm 3\%$.

The external temperature and humidity sensors are optional and can be purchased from GELU or its dealers.

All monitored parameters can be displayed through the CLI and web interface, and it also provide SNMP interfaces for access to third-party network management. (V1.3.0 version of it can support real-time monitoring through the intelligent power network management system "gelu platform" or smart terminal APP software.)

1.2 Control Function

- **Switch Control**

For Switched or Switched-POM models, you can switch one or more Outlet switches simultaneously through Web, CLI, SNMP, and so on. You can also set the output unit sequential on/off interval delay time, output unit restart, extra delay time, and outlet name.

- **Switch Timing Setting**

Set the control timing of the output socket switch to avoid current surge caused by all devices being powered on at the same time. The switch timing time is globally set, that is, it will take effect for each socket; during the waiting time period, the socket opening operation needs to wait for the end of the timing period to automatically resume the open state. Set this value to 0 if switch timing is not required.

- **Socket Group Definition**

You can select the corresponding group to operate batch control switch on the web page. For example, the default group cannot meet the requirements, and the customized group can be added or deleted.

1.3 Alarm Function

- **Alarm Level**

This product has two levels of alarms, Warning and Alarm. When warning, the system issues an early warning message to prompt maintenance for processing; when an alarm occurs, the system will issue an alarm message.

- **Alarm Setting**

The user can set the upper and lower limits of the rated current, the upper and lower limits of the rated voltage, the upper and lower thresholds of temperature and humidity, etc. according to the actual use requirements;

- **Alarm Trigger**

When the system detects that the electrical parameter or the environmental parameter value exceeds the threshold range, an alarm of the corresponding level is triggered;

- **Alarm Mode**

Provide a variety of alarm methods, such as system control panel status indication, buzzer beep; Web interface status indication; automatically send E-mail to the system administrator; SNMP send alarm status information; alarm interface output level.

1.4 History Record

You can view or download the history of electrical parameters, temperature and humidity within 60 days through the webpage.

1.5 Logging

The system saves the Syslog, which can filter and display various logs of the system through the management webpage, including the log of the relay control, the log of the operation command, and the like.

1.6 User Management

Users can create or delete users through web pages or the CLI and can grant users control over switches and other ports, granting control of one or more switches.

1.7 System Upgrade

The system can upgrade the firmware software online through the Web. The upgrade process does not affect the switching status of the control power supply and does not affect the normal operation of the power equipment. After the upgrade is complete, the system will automatically restart. The restart process does not affect the switch status of the control power supply and does not affect the normal operation of the power supply equipment.

1.8 Multi-user System Management and Operation

Supports multiple users to manage and operate the system through HTTP, HTTPS, SSH, SNMP, and Console. The CLI and Web login support the session timeout function. The default timeout period is 15 minutes. The administrator can set the timeout time on the Web.

1.9 Hardware Cascade

Support network cascading function. After cascading, each device can access through a separate IP address. The maximum number of cascading devices is 8.

1.10 Dual NIC redundancy

To enhance the redundancy of the system network connection, you can access the network of two different subnets on the panel for access.

2. Product Installation

2.1 Package Attachment

The package attachments for this series of products are as follows:

- **1U PDU Product**

L-shaped bracket ×2, M4 Screw ×4 (For L-shaped bracket fixation)

M5 Self-tapping screw ×4 (Used for vertical installation of 1U PDU)

- **0U PDU Product**

Nylon washer ×2, M4 Screw ×2

Z-shaped bracket ×2, M5 Self-tapping screw ×4

(Option) Straight bracket ×2, Nut plate ×2, M4 Screw ×4, M5 Screw ×4,
M5 Gasket ×4

(Option) Side mount bracket ×2, M4 Screw ×4

2.2 Installation

- **Horizontal installation of 1U PDU products using L-shaped brackets**

1. Fix the L-shaped bracket on the surface of both ends of the PDU (as shown in Figure

A). The recommended torque is 12~16 kgf•cm.

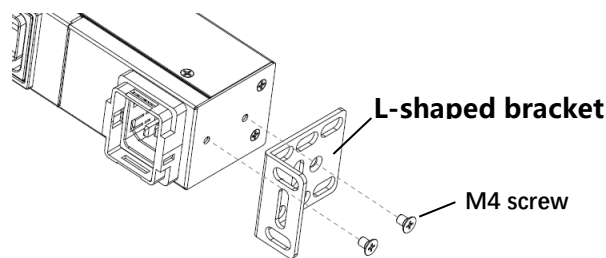

Figure A

2. Install the PDUs with the two L-brackets on the cabinet and fix them with screws (as shown in Figure B). The recommended torque is 21~25 kgf•cm, and the installation is complete.

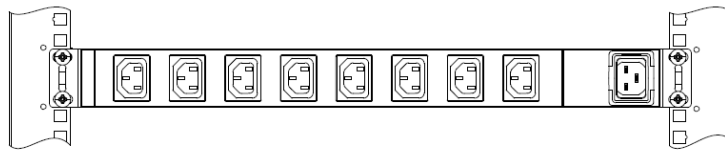

Figure B

- Vertical installation of 1U PDU products using L-shaped brackets

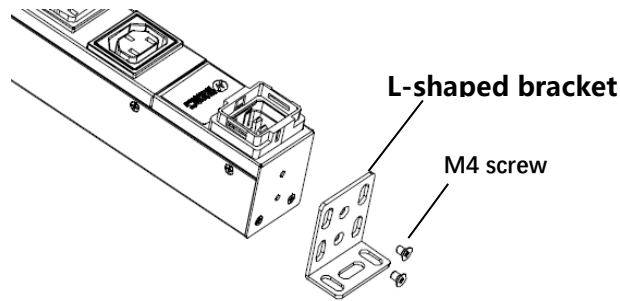

Figure C

1. As shown in Figure C, attach the L-shaped bracket to the PDU. The recommended torque is 12~16 kgf•cm.
2. As shown in Figure D, attach the PDU with the L-shaped bracket installed to the mounting backplane with the M5 self-tapping screws.

M5 self-tapping screw

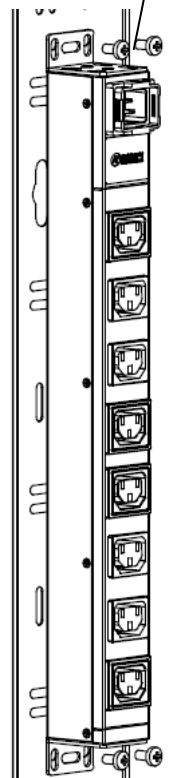

Figure D

● Install the 0U PDU product vertically using a nylon washer.

1. Measure the distance between the two pre-installed holes on the rack and record the values;
2. Slide the slider nut on the back cover of the PDU close to the “0” scale to the “0” scale and fix it with a nylon washer (as shown in Figure F). The recommended mounting torque is 12~16 kgf•cm.

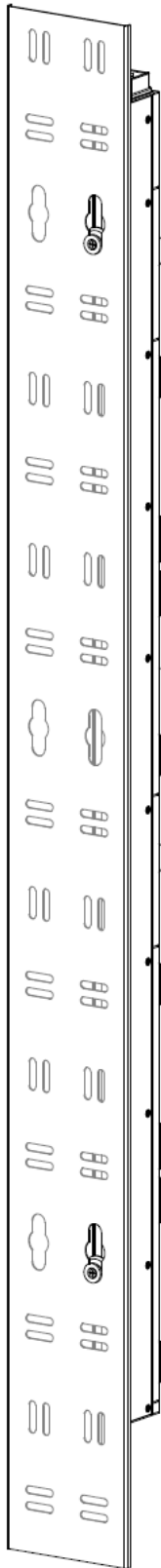

Figure E

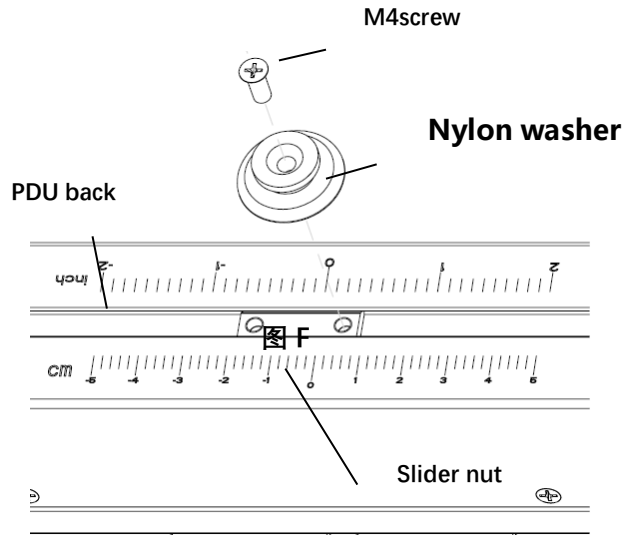

Figure F

3. Fix the other nylon washer and the slider nut according to the spacing of the mounting holes (as shown in Figure G). The fixed position can be measured using the tape or the back cover on the reference back cover;

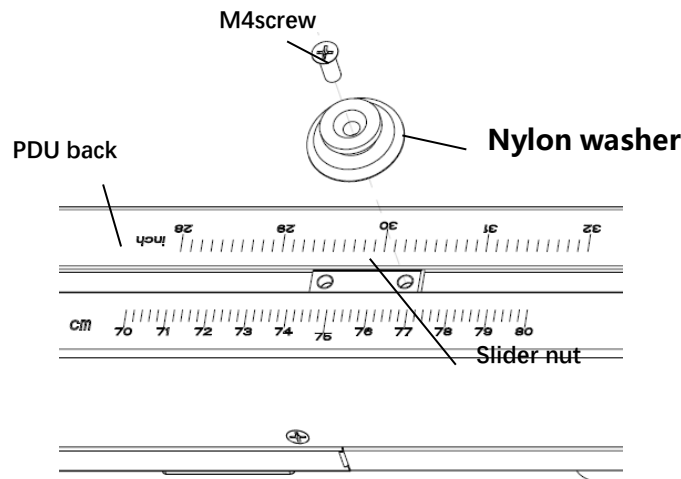

Figure G

4. Install the fixed nylon washer PDU into the rack. Make sure that the two nylon washers can be snapped into the rack mounting holes and the nylon washers are fully inserted into the mounting holes. As shown in Figure E, the PDU is fixed in place and the installation is complete.

- **Mount the 0U PDU product vertically using the Z-shaped bracket**

1. First install the two Z-shaped brackets to the cabinet mounting backplane (Figure J). The recommended mounting torque is 18~22 kgf•cm. The distance between the two Z-shaped brackets should be as close as possible to the reference PDU of the installed PDU back cover. Should not be too short or too long.

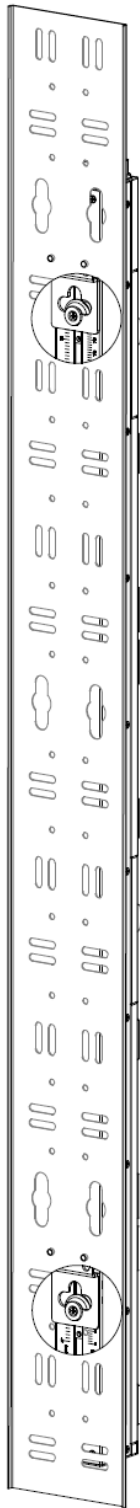

Figure H

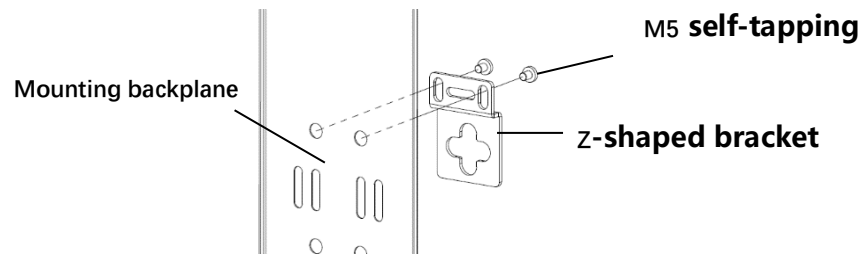
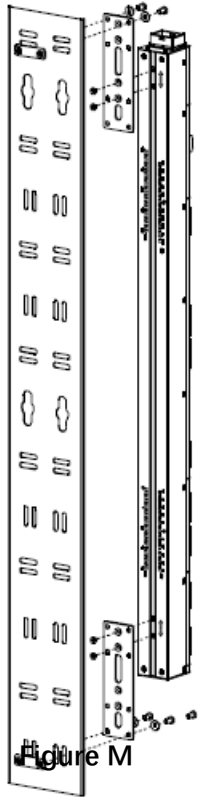
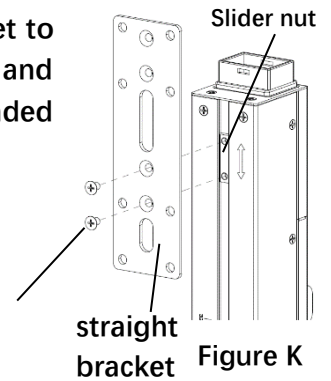

Figure J

2. Refer to ● Install the 0UPDU product using a nylon washer vertically. Install two nylon washers into the U-slot of the Z-shaped bracket, as shown in Figure H.

● **Vertical installation of 0U PDU products using a straight bracket**

1. Slide the PDU and cover the two slider nuts to the position of the upper and lower ends. Fasten the straight bracket to the PDU, and install the straight brackets at the upper and lower ends, as shown in Figure K. The recommended mounting torque is 12~16 kgf•cm.



2. Install the PDUs with the two straight brackets on the back panel of the cabinet. Place the nut plate on the back side of the back panel. Use the combination of screws and washers on the front to fix the straight bracket to the back panel. Show. The recommended mounting torque is 21~25 kgf•cm.

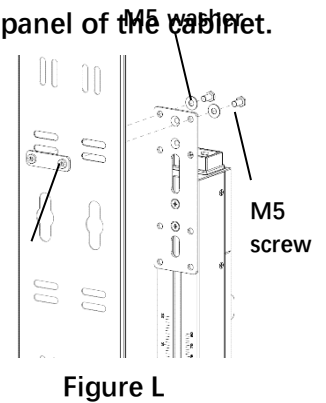

3. Install the straight brackets at the upper and lower ends onto the backplane. As shown in Figure M, the installation is complete.

● **Mount the 0U PDU product vertically using the side mount bracket**

1. Slide the slider nut to the desired position and secure the side bracket to the slider nut using the mounting screws, as shown in Figure N. Recommended torque is 12~16kgf.cm.

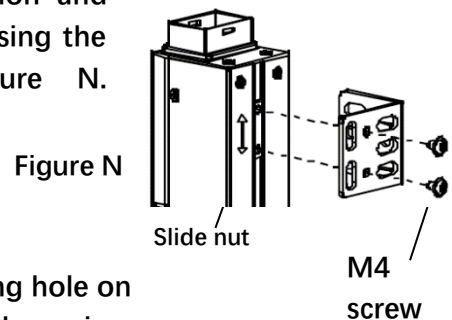

2. Install the nylon washer to the corresponding hole on the side bracket as shown in the figure. As shown in Figure P, the recommended torque is 12~16kgf.cm.

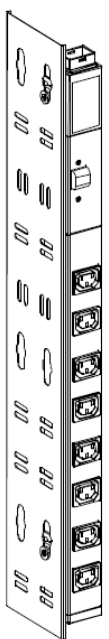
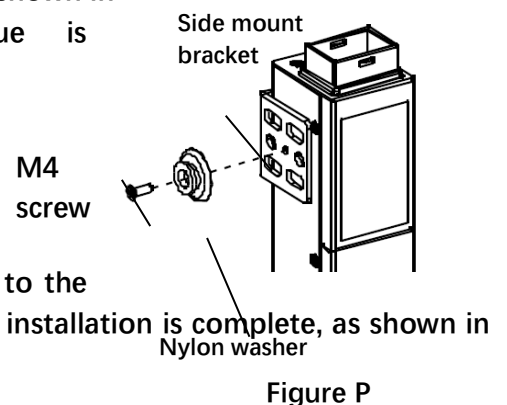

Figure R

3. Snap the fixed nylon washer on the PDU to the corresponding position on the rack, ie the installation is complete, as shown in Figure R.

Figure P

3.Product Use

Gelu Smart PDU is a combination of the following components, input components, output sockets, overcurrent protectors, communication interfaces, and displays. .

3.1 Start using

The PDU requires various communication signals and power connections before use, and the components are properly configured.

- **Power connection**

Connect to the power supply according to the rated power parameters indicated on the PDU nameplate label. **The correct power source must be connected, otherwise it may damage the device or even pose a personal injury hazard.**

According to the model, PDU power access is not the same. It can be divided into two models: power cord and power plug.

Input power plug

If the PDU is a model with a power cord, connect the power cord connector to the power socket of the corresponding specification. The distance between the input power outlet and the PDU cannot be greater than the length of the input power line of the PDU. It is highly recommended to use a connector with a latch on the power supply side for a safer connection.

IEC60320 C20 inlet

Use IEC60320 C19 plug to connect to the PDU with C20 inlet, please note that it needs to be connected. It is highly recommended to use a C19 connector with a latch to connect to avoid the connector being plugged in.

SSEMCO HC inlet

Insert the "convex" portion of the HC input plug into the "convex" position of the HC connector, make sure the tabs on the plug are snapped into the holes in the connector.

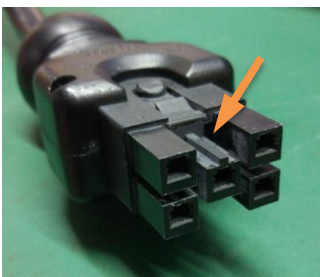

HC connector



HC Inlet



Connection Status

● **Accessory Connection**

For the monitoring of ambient temperature and humidity on the PDU, the temperature and humidity sensor need to be purchased from the company and connected to the Sensor interface (orange) on the panel to support the direct access of the two groups of temperature and humidity sensors;

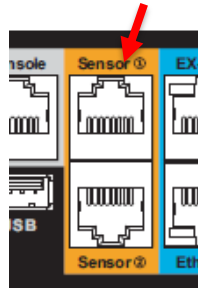

● **Communication Connection**

Gelu Smart PDU supports Ethernet, RS-485 and local console access. If you use network communication, you can use standard network cable to connect to Ethernet or EX-OUT interface (blue), and serial bus communication to RS-485 interface. Green), local serial communication access to the console interface (gray);

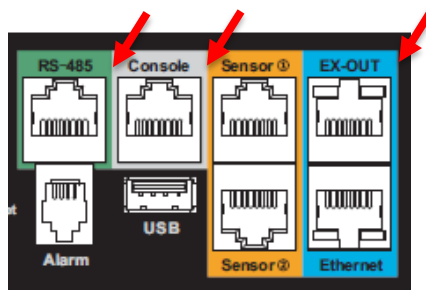

● **Metered LCD Modul Connection**

Some smart models support external LCD display module connection. If you need to view the PDU running status on the panel, you can connect the external display module to the PDU. Pay attention to the position of the display module and the contacts on the PDU when connecting. Wait for 2-3 seconds after the connection, the status and parameter values of the PDU can be displayed on the display module;

Note: In general, the 0U model can be connected to the display module on the front or on either side, but it can not connect with 2 or more display modules at the same time. The display module should be secured by the screw on the top.

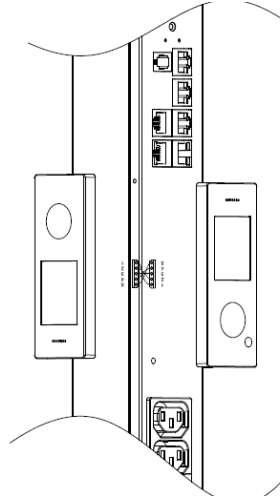

- **Circuit Breaker**

If there is a PDU with a circuit breaker, it is necessary to confirm that the circuit breaker conforms to the electrical specifications of the local country or area before using;

The circuit breaker may be placed in the disconnected position before leaving the factory. Before using, it must be connected as the following steps before it can be used normally;

1. Open the circuit breaker cover
2. Turn the breaker lever from OFF to ON, then close the cover.



3.2 Panel Instruction

0U The front panel of the model is available in two different models: with LCD display and without LCD display panel.

1U/2U Model provide another control panel. The part of metered section is on the same side as the output socket, and the communication port is located on the back of the output socket. LED seven-segment digital LED is used to display input power parameters.

- **0U model with LCD control panel**

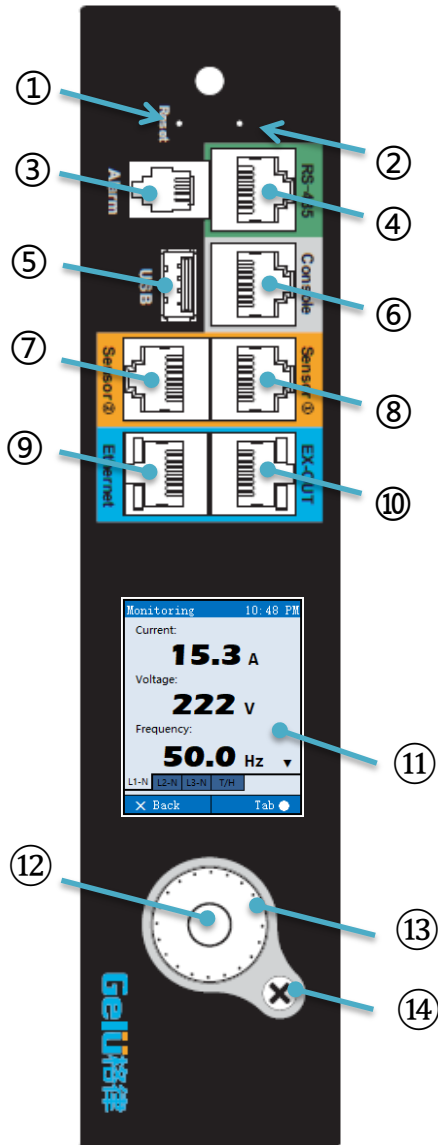

location	Name	Description
①	Reset	Reset button
②	Button	Factory maintain button
③	Alarm	Alam signal output
④	RS-485	(Green area) RS-485 bus interface
⑤	USB	USB interface
⑥	Console	(Gray area) RS232 interface
⑦	Senser②	(Orange area) Sensor 2
⑧	Senser①	(Orange area) Sensor 1
⑨	Ethernet	(Blue area) External network interface
⑩	EX-OUT	(Blue area) Cascading expansion interface
⑪	Display	LCD Displayer
⑫	●	(Gray area) Menu/Enter/Others
⑬	Scroll Wheel	(Gray area) Button for selection
⑭	×	(Gray area) Back/Cancel

NOTE: Alarm and RS-485 are optional, not for all of models.

● 0U Model without LCD control panel

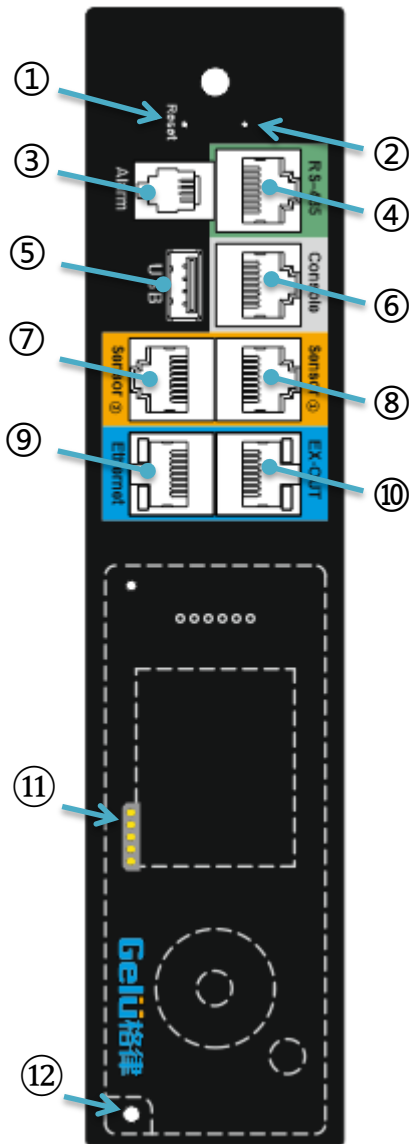

Place	Name	Description
①	Reset	Reset button
②	Button	Factory maintain button
③	Alarm	Alam signal output
④	RS-485	(Green area) RS-485 bus interface
⑤	USB	USB interface
⑥	Console	(Gray area) RS232 interface
⑦	Sonser②	(Orange area) Sensor 2
⑧	Sonser①	(Orange area) Sensor 1
⑨	Ethernet	(Blue area) External network interface
⑩	EX-OUT	(Blue area) Cascading expansion interface
⑪		External LCD display contact
⑫		External LCD display securing nut

NOTE Alarm and RS-485 are optional, not for all of models.

● Interface for 1U/2U Model

The interface type provided by the 1U/2U model is the same as that of the 0U model, see the figure below.

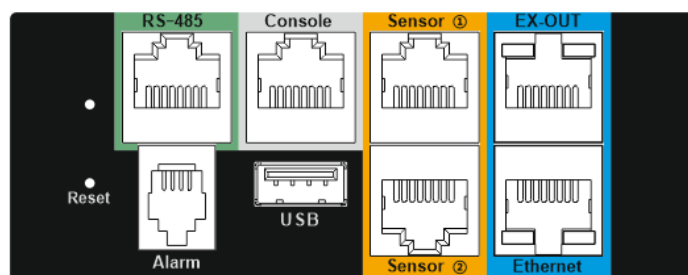

Area	Interface Name	Description
Green	RS-485	RS-485 Bus Interface
Gray	Console	RS232 Interface
Orange	Sensor	Sensor Interface
Blue	Ethernet	Interface of External network and Cascading expansion
Others	Reset	Reset Button
Others	Button	Factory maintain button
Others	Alarm	Alarm Signal Output
Others	USB	USB interface

NOTE: Alarm and RS-485 are optional, not for all of models.

● **TFT LCD Displayer and operation**

LCD displayer for 0U model:

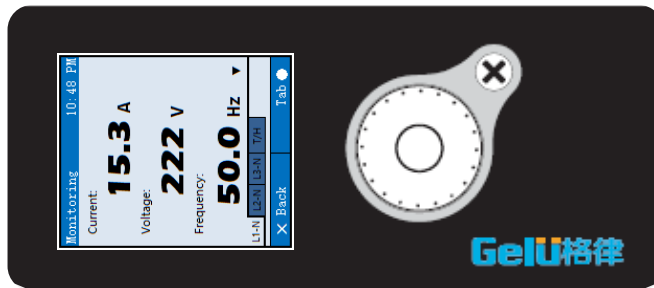

Including TFT LCD display and operation buttons (4 operations), users can view power consumption parameters and environmental parameter information on this display. Output control function is deployed in Switch models. In addition, the orientation of the displayed information can be adjusted to the best viewing direction no matter the PDU is upside down so that the user can operate it conveniently and intuitively.

There are 4 types of button operation:

Illustration				
Operation	Down or Page down	Up or Page up	Enter	Back or Menu

More detail as ["3.3 LCD INTERACTIVE INTERFACE"](#) .

- **Segment code LED Display**

The 1U/2U model provide two 3-digit digital Segment LED, which are use for displaying the electrical parameter information of the input power. There are 4 parameter information: Input current, voltage, power and power factor. 2 of 4 parameter information are displayed at a time and switched every 5 seconds. the orientation of the displayed infomation can be adjusted to the best viewing diection no matter the PDU is upside down so that the user can operate it conveniently and intuitively.

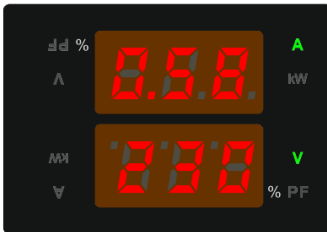

The figures showed in digital segment LED are as below, they are 1、 2、 3、 4、 5、 6、 7、 8、 9、 0.



Display content description:

1. When light of "A" is on, the value shown on the left is the current, as shown in the figure of 0.58A.
2. When light of "V" is on, the value shown on the left is Voltage, as shown in the figure of 230V.
3. When light of "kW" is on, the value shown on the left is active power.
4. When Light of "%PF is on, the value shown on the left is the power factor.

- **Reset/password and network address reset operation**

The smart module can be reset by long pressing the "Reset" button on the panel for >5 seconds by using the insulating probe. The intelligent module reset operation will not affect the power supply of the outlet. For other reset methods, such as web pages and CLI, please refer to the related page

3.3 LCD interactive interface

- **Startup screen**

After the power is turned on or the reset command is executed, the LCD displays Gelu icon and the progress bar. When the progress bar is complete, it enters PDU control panel system



NOTE: If it can't enter system even though the progress bar is complete, please check the contact between external metered modular and PDU.

● First configuration

If you have not configured the PDU for the first time or after booting from the previous boot, the system will automatically enter the “First Time Setup” screen, where you can configure the contents in the following figure through the buttons on the operation panel. Including: Enabled state of the network IPv4 DHCP service, IP address, subnet mask, gateway, DNS, and current date/time settings.

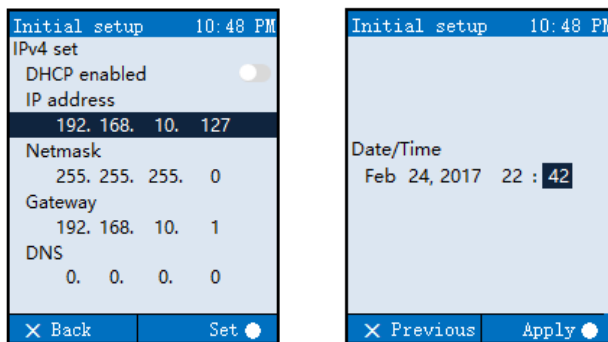

Configuration Instruction:

1. Use the knob switch to rotate the cursor forward and backward and move the cursor to the item to be adjusted. To modify the IP address, rotate the cursor to `192.168.10.127`;
2. Press the middle button ● to start setting, the cursor will stop in the first modified IP field, and adjust to the correct values by the rotation clockwise or anticlockwise of the rotary switch
3. Press the middle button ● again to modify the next field until the last field value adjustment is completed. Press the middle button ● to return the cursor to the entire field. `192.168.10.127`, then complete the setting of IP address.

The similar operation of Date/Time setting.

NOTE: The first setting is very important. Once you have set it, you will not be able to enter this page again. Unless the factory reset operation will be presented again; if you want to modify the IPv4 information later, you can only use the web page or CLI.

After the “First Configuration” is completed, press  to enter the main screen, and the electrical parameter information and environmental parameter information are displayed in turn.

- **Display area/Main screen**

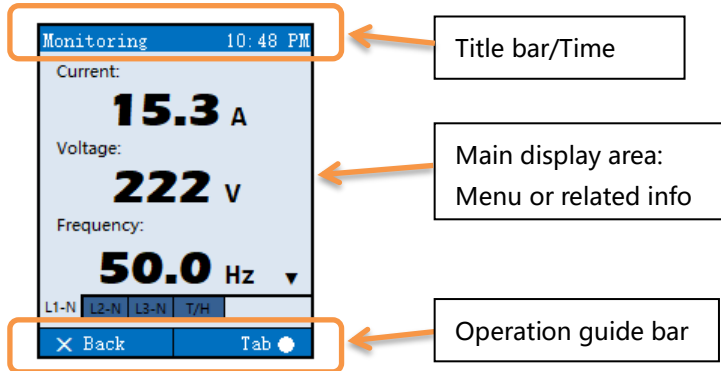

Title Bar/Time: Displays the title of the content and the current system time; the time is displayed in 12-hour format, AM stands for AM and PM stands for PM.

Main display area: Displays the specific information of the selected item.

Operation guide bar: Indicates the action command of the relevant button.

The upper and lower columns (title bar and operation guide bar, the same below) color: blue indicates that the PDU is operating normally, yellow indicates that there is currently warning information, and red indicates that there is currently alarm information.

View the main interface display content:

1. The main interface displays two types of content: electrical parameters and ambient temperature and humidity. The electrical parameter information is divided into one tab (Single phase type) and three tabs (3 phase type) according to the input power phase, and the temperature and humidity information is only one tab. Electrical parameter information 3 screens per tab, respectively display (1st screen) current / voltage / frequency, (2nd screen) active power / apparent power / power factor / energy consumption, (3rd screen) overcurrent protector Current; temperature and humidity Tab is 2 screens, each screen displays a set of temperature and humidity information. Please see the "Monitoring" section below for details.

2. After the normal state or after stopping the operation for a period of time (30 seconds), the main interface scrolls in the order of each screen.

3. Use the knob switch to rotate the page to view the main interface. If the main display area has the “▼” icon, turn it clockwise to scroll down. If the main display area has the “▲” icon, turn it counterclockwise. You can scroll up to view.

4. Use the middle button ● to quickly switch between each "Tab"

● **Main Menu**

Press  to enter the main menu from main screen, different menu items will be displayed according to different models. The left picture below shows the main menu interface of the Switched/Switched-POM/Smart-POM model, and the right picture shows the main menu interface corresponding to the Smart model.

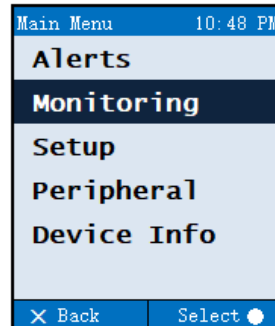
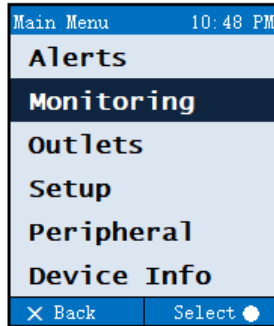

Use the knob switch to adjust the selected menu item up and down, press the middle button

- to enter the item. The specific contents of each menu item are as follows:

Menu Command	Function
Alerts	All of alerts and alert events.
Monitoring	You can view the electrical parameter information according to the power “phase”, including current, voltage, frequency, active power, apparent power, power factor, energy consumption and current of each branch overcurrent protector. You can also view the temperature and humidity info if sensor is connected to the panel.
Outlet	If the model you purchased is supported, the electrical parameter information of each output socket can be displayed. If the "front panel control authority" is enabled, you can also turn on, off, and restart each output socket.
Setup	The buzzer switch, LCD display, time (if you are authorized) can be set or viewed.
Peripheral	Display sensor and USB peripheral information connected to the PDU, such as ambient temperature and humidity sensor, USB wireless network card, etc.
Device Info	Display PDU device information, current power-on running time, network information, and so on.

● **Alerts Events**

The Alert interface only warns about the current failure. Alert includes warnings and alarms. The severity of the alert is lighter than the alarm and is used for minor warnings; similarly, the Alarm is used for critical warnings to alert the user to deal with it in time. The warning includes Low Warning and High Warning. The alarm includes Low Alarm and High Alarm and other faults. For details, see the description of the alarm below.

The color of the upper and lower columns is different: no alarm, it is blue; only the warning has no alarm, it is yellow; there is alarm, it is red. The same is true for other LCD display interfaces. The severity of Alert can be easily distinguished by the color of the upper and lower columns.

Alert content color distinction: Alerts and alarms are identified by yellow and red, respectively.

The following are: no warning and alarm, no warning, no alarm, warning and alarm. When the Alerts and events are many, it can be identified by the up and down arrow marks on the screen and can be viewed by turning the knob switch.

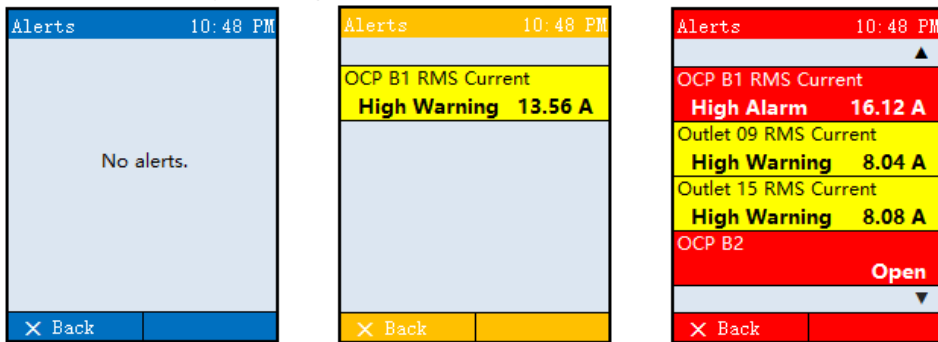

The contents of the alarm include:

1. Electrical parameters or sensor threshold violations, such as Phase voltage, Outlet current, temperature sensor temperature overrun, etc.;
2. OCP (over current protection) is tripped
3. Device failure, such as memory, metering chip, network chip, etc.;
4. Communication failure between PCBAs.

● **Monitoring parameter view**

The current electrical parameters of each phase and the detected values of two temperatures and humidity are displayed in real time. Under normal circumstances, a 10-second round-trip display is performed in these contents, that is, each screen is displayed for 10 seconds and then switched to the next display screen. If there is a button press, the display changes to a static display, and the duration of the static display is 30 seconds. If the button is not pressed for 30 seconds, it is switched to the round robin display.

The following three figures show the electrical parameters, including current, voltage, frequency, active power, apparent power, power factor, accumulated energy, and OCP current.

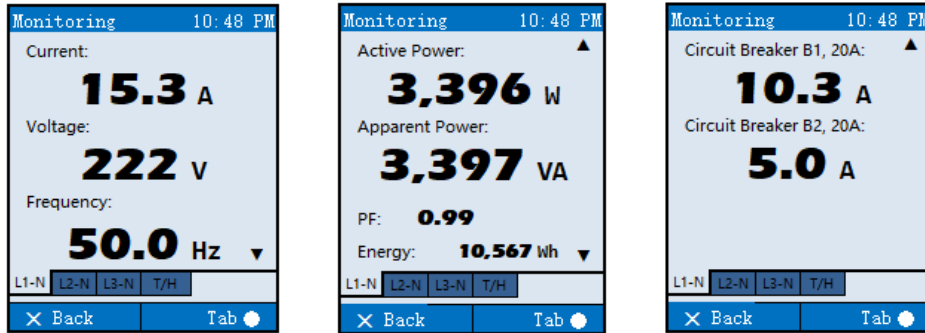

NOTE:

- a. For models without OCP, the OCP current page is not displayed.
- b. The description line **Circuit Breaker B1, 20A:** consists of the OCP name, ID, and current rating.

The following is the display of the temperature and humidity values, and the collected values of the two temperature and humidity sensors are fixedly displayed. Even if some temperature and humidity sensors are not connected, this interface is displayed, and the display value is indicated by "N/A". The left picture shows the temperature and humidity sensor connected, and the right picture shows the temperature and humidity sensor not connected.

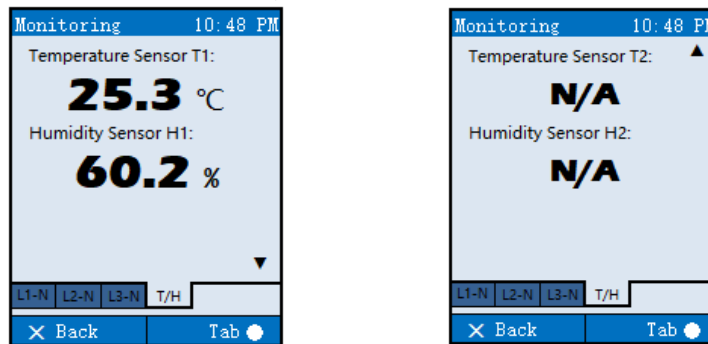

NOTE: Description **Temperature Sensor T2:** is consist of temperature sensor name and ID, same as humidity sensor.

● **Outlet information and control**

The Outlet menu is only available for Smart-POM, Switched, Switched-POM models. A single page can display up to 6 Outlet information, which can be changed or turned through the knob switch. At the same time, the selection cursor will also change, and the socket type and electrical parameters corresponding to the Outlet will be displayed.

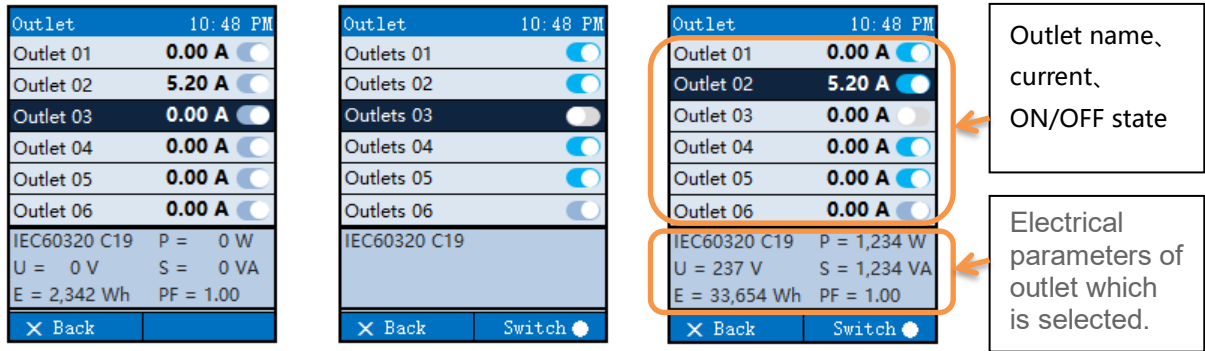

ON/OFF: ON/OFF definition

- : Switchable and currently in the ON state;
- : Switchable and currently in the OFF state;
- : Unswitchable and only in the ON state;

Socket type and electrical parameter abbreviation meaning

- IEC60320 (abbreviated as IEC320) C19: socket type;
- P: Active power;
- U: Output voltage;
- S: Apparent voltage;
- E: Cumulative power;
- PF: Power factor.

◆ For the switch that is switchable and in the OFF state, press the “●” button and follow the corresponding prompts for ON operation.

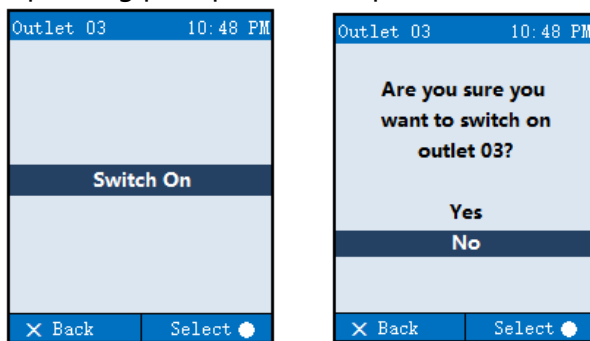

◆ For the switch that is switchable and in the ON state, press the “●” button and follow the corresponding prompt for OFF operation..

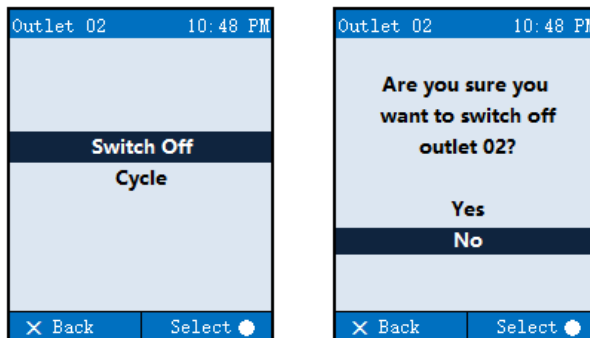

◆ For the switch that is switchable and in the ON state, press the “●” button and follow the

corresponding prompts for the Cycle operation. (Cycle is: Outlet first OFF and then ON).

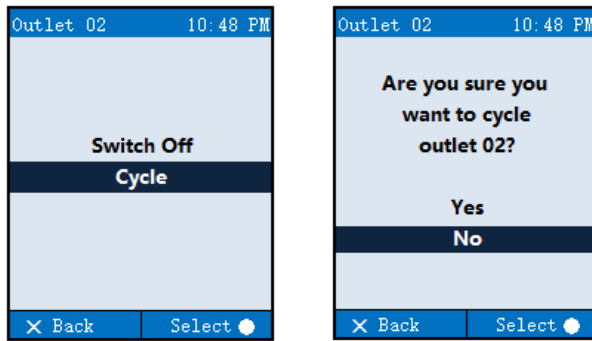

After the above actions are performed, the display automatically switches to the socket list interface.

◆ If the "front panel control" permission is turned off by such as web page or a CLI, the control operation of the outlet cannot be performed, see the illustration on the left. Similarly, for an outlet that is set as a lock by a web page or such as a CLI, the outlet cannot be performed. For the control operation, see the illustration on the right.

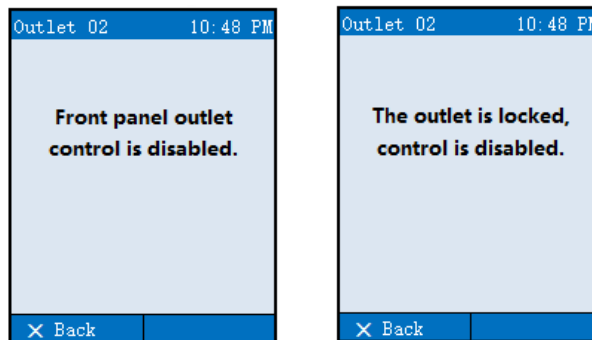

● **Setup configuration**

Through this interface, the following functions can be set or viewed. Only items that can get the focus can be set. Gray font items can only be viewed and cannot be set.

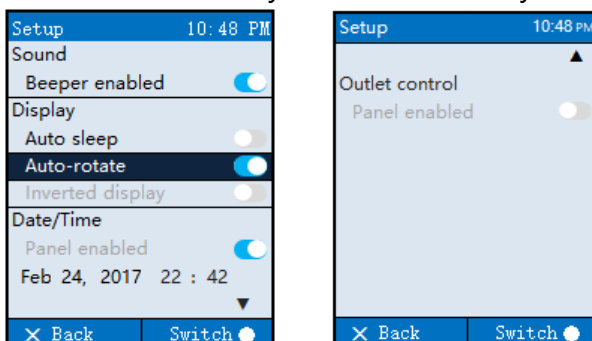

ON/OFF Icon definition

- : Enable
- : Disable

The functions are described as follows:

Menu	Command	Function
Display	Beeper enabled	Enable the buzzer. When the alarm occurs (the color of the upper and lower columns is red), the buzzer beeps every 2 seconds.
	Auto sleep	The LCD display enables automatic standby mode. Under normal operating conditions, if there is no button operation for 60 seconds, it will automatically enter standby mode and the LCD will turn off the backlight.
	Auto-rotate	Enable display content to automatically adapt to the installation direction.
	Inverted display	When the "Auto-rotate" function is not enabled, you can set the fixed direction of the display content. You can enable reverse display or reverse display
Date/Time	Panel enabled	The display module can set a status indication of the time. You can only check if the time can be set and cannot be changed. See the note.
	Date/Time	If "Panel enabled" is enabled, you can set the time here.
Outlet control	Panel enabled	The display module controls the status indication of the Outlet switch. You can only see if you can control the Outlet switch and cannot change it, see the note.

Note: Some of the local operation rights are turned off or on. You need to set it to "Disabled" or "Enabled" through the web interface or CLI. If it is set to "Disabled", only the current status of the setting is displayed, and the setting changes are not allowed.

Configuration Method

1. The setting of "Date/Time" refer to "first configuration" → "configuration instruction"
2. Another configuration can be switched by using ● of knob switch.

● **Peripheral**

This display interface dynamically manages externally connected sensors and USB peripherals in real time. If the sensor or USB peripheral is removed from the PDU body, the display interface naturally does not display the corresponding device.

Sensors include: ambient temperature and humidity, access control, water immersion, smoke, airflow and other sensors.

USB peripherals include: USB flash drive, USB wireless network card, webcam, etc.

The following are the displays that are not connected to any peripherals and access sensors. Up to four peripherals can be displayed per page. If there are more than four, there will be up and down arrows on the screen to identify them, and you can view them by turning the knobs

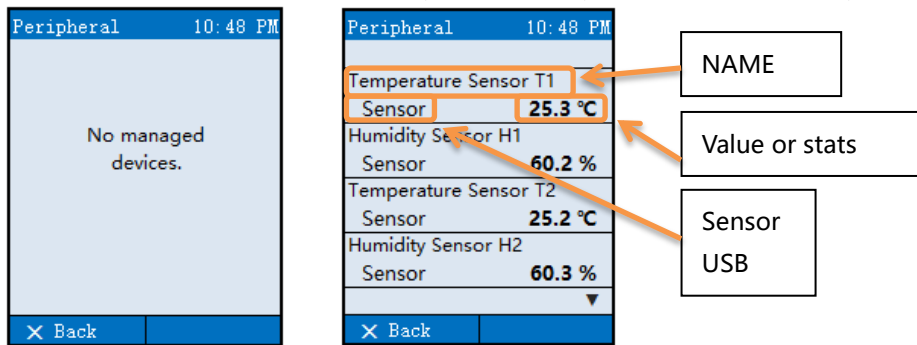

● **Device Info**

Displays PDU device information, current power-on running time, and network information. Introduced separately below.

1. Device Info.

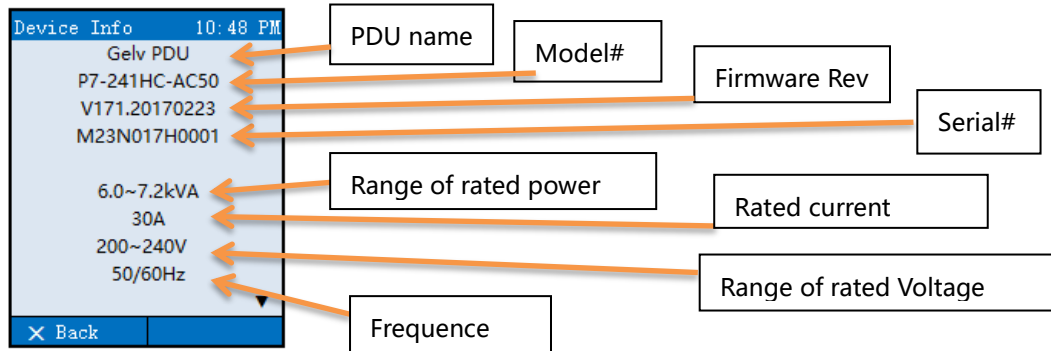

2. Network connection, MAC, uptime

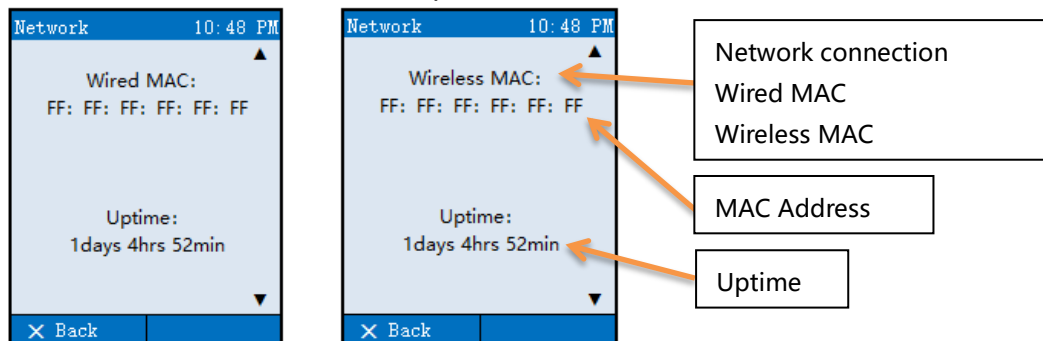

3. Network information

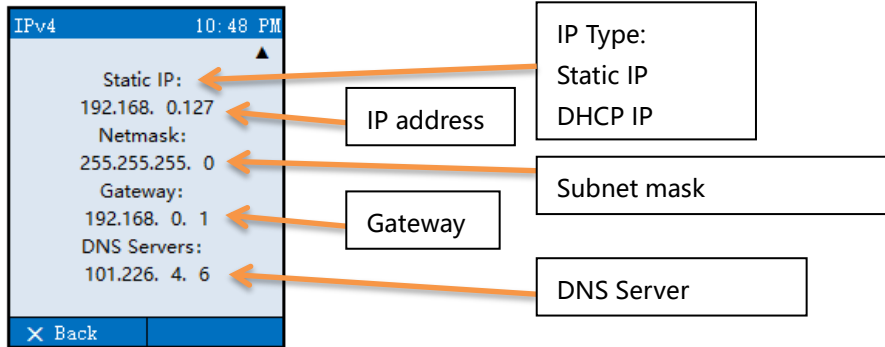

3.4 Outlet

Smart-POM, Switched, Switched-POM series models have LED indicators for indicating socket status;

LED state and description on the output socket

LED Stats	Description
non-luminance	PDU not power-on or the outlet not power-on
Switched by green/yellow/red color	PDU is in power-on progressing
Luminance	The output socket voltage value and power factor have not reached the alarm state
Flashing	The output socket voltage value or power factor exceeds the alarm threshold (not flashing in the warning state); if the entire group of sockets is found to be flashing, the overcurrent protector may be disconnected. Please check the overcurrent protector.

LED color and description

LED color	Description
Green	The load level of the outlet is in a normal state
Yellow	The load level of the outlet is in an alert state.
Red	The load level of the outlet is in a alarm state.

Note: The socket status indicator is currently only available for models with SSEMCO R6 series for output sockets; it is recommended to use SSEMCO special power cord with transparent plug.

4. Web operation instruction

This chapter describes the web management interface.

4.1 Browser support

You can log in with the following browser:

- Microsoft Edge;
- Firefox;
- Chrome;

4.2 log in

1. Open a browser and enter the PDU IP address in the address bar (the factory default IP address is 192.168.10.127) and press Enter.

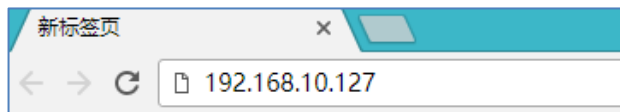

Note, if you forget the IP address, you can view it on the LCD panel of the local panel. Refer to 3.3 LCD Interactive Interface - Device Info. If the model you purchased does not have a standard LCD display, you can use the PC to connect to the Console to view the CLI interface. Please refer to the CLI for instructions.

2. If there are any security alertes, click on the prompt page: Adavance-> Add Exception), screen of log in as below:

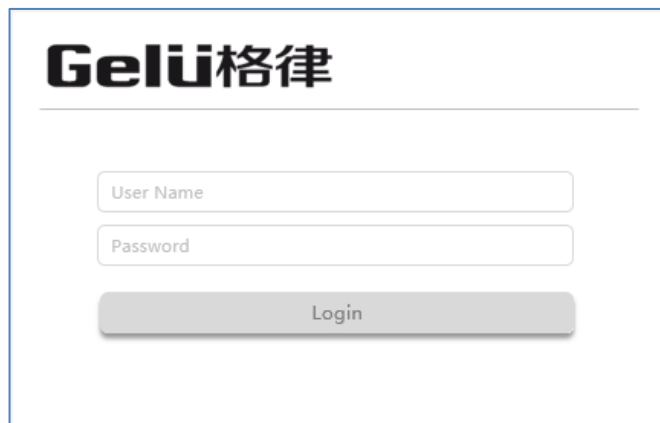
A screenshot of the Gelu web management interface login page. The page features the 'Gelu 格律' logo at the top. Below the logo, there are two input fields: 'User Name' and 'Password'. A 'Login' button is positioned below the password field.



3. Enter the username in the Username field (there is only one "admin" user by default when no new users are added) ;

Enter the password in the Password field (the default password for the factory admin user is: "gelupower") ;

Note: User names and passwords are case sensitive and must be entered correctly.

4. Click "Login" or press "Enter" to log in.

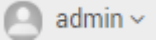
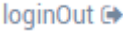
4.3 Web exit

1. Move the mouse to the upper right corner of the web interface  and the drop-down LogOut button  will pop up. Click the button to exit.
2. Or, click the close button in the top right corner of browser. .

4.4 Web interface description

After the login is successful, enter the main web interface, which mainly includes three major areas:

1. Navigation area:
 - Display the main menu Overview, Power, Peripherals, Configuration, User Management, Maintenance and its submenus;
2. Login information area:
 - The navigation area expands and hides the button, the device model, the firmware version information, the current login user name, and the logout button;
3. Display area: Displays information about the navigation area submenu.

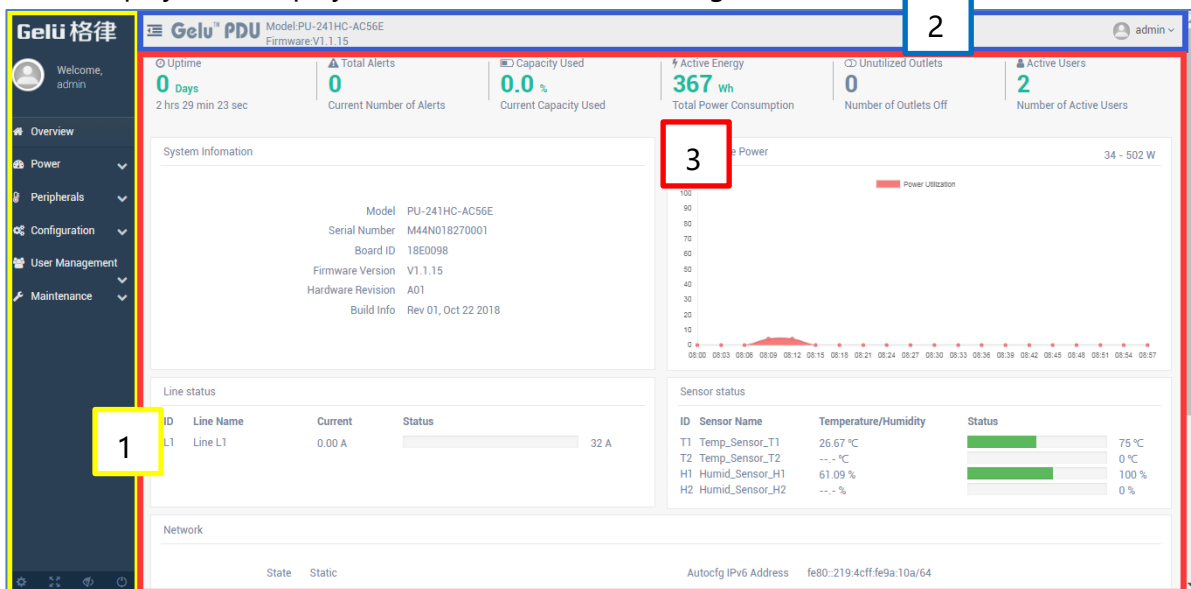

4.5 Navigation area (menu)

Accoding to the model, in Main Menu, the Web Navigation Zone will display all or part of the following submenu items:

Menu	Description
Overview	Overall preview of PDU status, including: device running status (power-on running time, alarm

	information summary, PDU load current percentage, accumulated power consumption, number of idle sockets, number of users connected to PDU) / system information / active power history curve / Line Status / Sensor / Network Configuration Information
Power	Electrical parameter information monitoring, configuration, and output port settings, control
Inlet	The electrical parameter information of the power input includes line status/phase status/history curve/configuration
Over-Current Protectors	OCP status, information viewing and configuration
Outlets	Outlet status viewing, control, group control, control settings, threshold settings, etc.
Peripherals	External accessory status monitoring, including various environmental sensors and subsequent versions will support more external devices
Sensors	Environmental sensors display areas, including temperature, humidity, and access control, flooding, and smoke that will be supported later.
Configuration	System Configuration / Network Configuration / Connection Settings
System	About/ Front-Panel/Time setting
Network	network protocol settings
User Management	User management
Users	User list and editing
Users Preferences	User parameter setting
Change Password	Change Password
Maintenance	Maintain tool
Ping	Ping
Upgrade Firmware	System upgrade
Backup/Restore	Configuration backup and recovery
History Data Files	Historical data download
Files	System file viewing and download
View Event Log	View Event Log
Restart	Restart

4.6 Overview

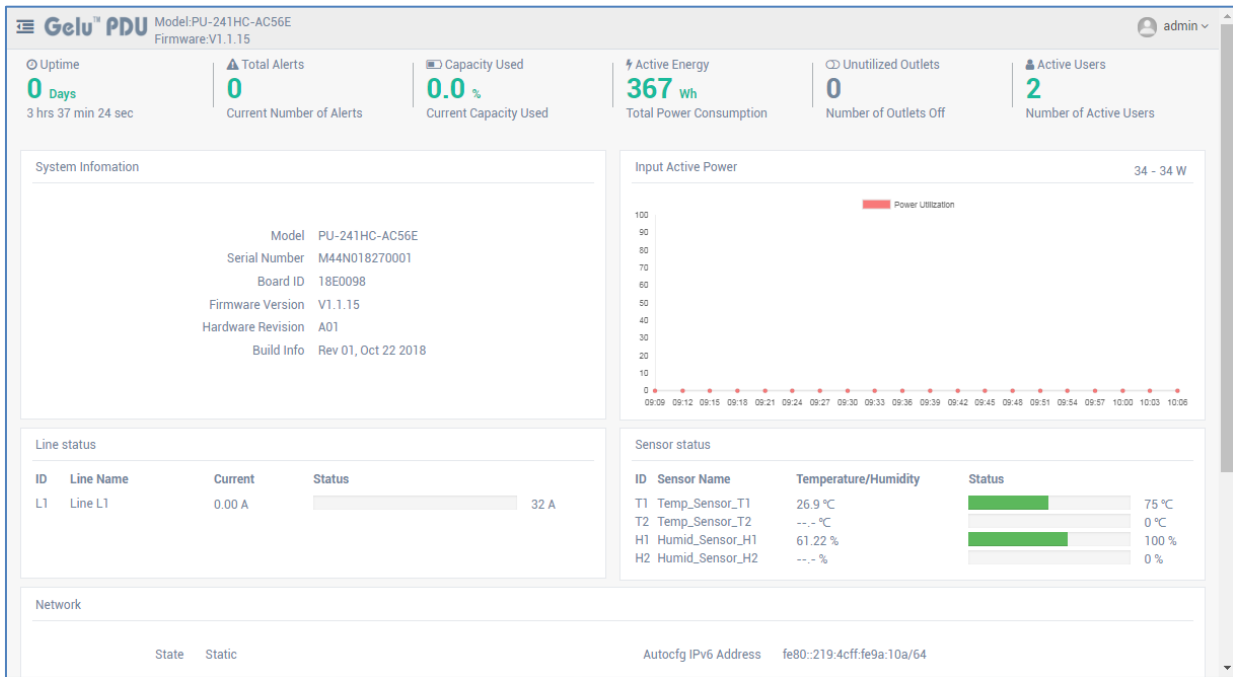

● **Device running state**



Uptime: Power-on running time refers to the running time of this power-on and is cleared after power-off.;

Click to jump to: [Configuration/System/About](#);

Total Alerts: Summary of alarm information, showing the total number of alarms of the current device;

Value Color: 0 No alarm, green;

≥1 Only Warning, orange; At least 1 Alarm, red;

When the alarm value is ≥ 1, click the value to pop up the alarm list details as follows;

Event	Value	Status	Action
Phase P1 RMS Voltage	236.1v	High Alarm	Details
Temperature Sensor T1	26.87	High Warning	Details

Click the Details button to jump to the corresponding page;

Capacity Used: PDU load current ratio, current load current to rated current ratio (percentage);

Value color: 0~70% green,

70-80% orange,
>80% red

Click to jump to: [power/inlet/status](#);

Active Energy: The PDU consumes a total of electrical energy ;

Click to jump to: [power/inlet/status](#) for more details;

Unutilized Outlets: Number of unused outlets;

Value Color: 0 gray;
>0 green;

Click to jump to: [power/outlet/status](#);

NOTE: Switch model counts the number of outlets that are not powered, and the number of Smart models is 0.

Active Users: The number of current user connections, the number of users connected to the PDU, including the number of users logging in to the Web from different hosts and the number of users logging in to the CLI;

Value color: green

Click to jump to: [User/List](#).

- **System information**

System Information	
Model	PU-241HC-AC56E
Serial Number	M44N018270001
Board ID	18E0098
Firmware Version	V1.1.15
Hardware Revision	A01
Build Info	Rev 01, Oct 22 2018

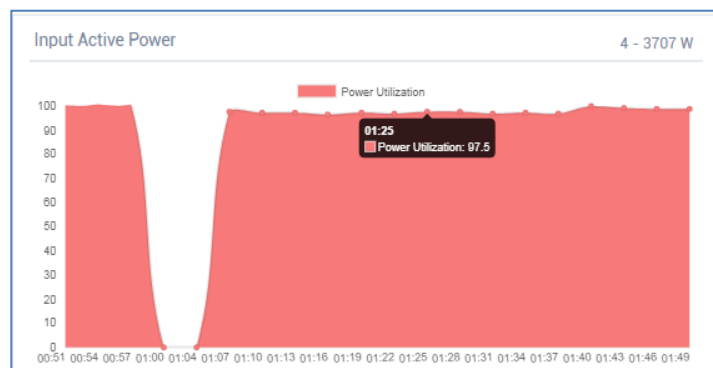

Model No./ Serial Number/ Board ID/Firmware Version/Hardware Revision/Build Info

- **Input Active Power historical curve**



- 1) Horizontal axis: the time axis of the last 2 hours, the origin is the first 2 hours, and Max is the current time point (the specific value is not displayed);
- 2) Vertical axis: percentage of current active power and maximum active power: 0-100%;
- 3) 4-3707 W: Display the minimum and maximum values of active power for nearly 2 hours;
- 4) Other: The mouse is placed on the point of the curve to display the details of the time point.

● **Line status**





Line status			
ID	Line Name	Current	Status
L1	Line_L1	25.30 A	 32A
L2	Line_L2	13.50 A	 32A
L3	Line_L3	32.00 A	 32A

- 1) 32A: maximum line current value;
- 2) color bar length: the ratio of real-time load current to maximum range current;
- 3) Electrical parameter color bar, the meaning of different colors:

Item	Below the lower limit alarm value	Below the lower limit alert value	Normal	Over the lower limit alert value	Over the lower limit alarm value
electrical parameter	Red	Yellow	Green	Yellow	Red

Note: Alarm thresholds can be set by the user. [4.7](#)”.

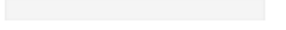
● **Sensor status**

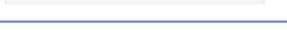
Sensor status			
ID	Sensor Name	Temperature/Humidity	Status
T1	Temp_Sensor_T1	25.37 °C	 75 °C
T2	Temp_Sensor_T2	25.81 °C	 75 °C
T3	Temp_Sensor_T3	--. °C	 0 °C
H1	Humid_Sensor_H1	62.42 %	 100 %
H2	Humid_Sensor_H2	60.93 %	 100 %
H3	Humid_Sensor_H3	--. %	 0 %

- 1) Temperature 75 ° C: the highest value that the sensor can detect;
- 2) Relative humidity 100%: the highest value detectable by the sensor;
- 3) Temperature and humidity color bars, the meaning of different colors:

ITEM	Below the lower limit alarm value	Below the lower limit alert value	Normal	Over the lower limit alert value	Over the lower limit alarm value
Temperature	Violet	Blue	Green	Yellow	Red
Humidity	Red	Yellow	Green	Blue	Violet

Note: Various alarm thresholds can be set by the user. Refer to [4.7](#).

- **Network**

Displays information about the current network connection, such as State status, IPv4 address, IPv6 address, and so on.

Network			
State	Static	Autocfg IPv6 Address	fe80::219:4cff:feaa:32/64
Link	Up	Stateless DHCPv6 Address	
Speed	100 Mbps	IPv4 Address	192.168.10.127
Duplex	Full	IPv4 Subnet Mask	255.255.255.0
Negotiation	Auto	IPv4 Gateway	
Ethernet MAC Address	00:19:4c:aa:00:32	DNS	

4.7 Power monitoring and setting

- **Inlet state and setting**

This page allows you to view the status of the Inlet population, the status of the Line and the status of the Phase, as well as the ability to modify the Inlet name and configuration threshold parameters.

Inlet Status

Active Power 0 w Total Active Power	Apparent Power 0 VA Total Apparent Power	Power Factor 1.00 Total Power Factor	Active Energy 0 Wh Total Power Consumption	Frequency 50.0 Hz Line Frequency	Voltage deviation 1.7 % Nominal voltage deviation...
--	---	---	---	---	---

Item	Description
Active Power	Active Power
Apparent Power	Apparent Power
Power Factor	Power Factor
Active Energy	Active Energy (It can be cleared by the Reset button in the Power/Inlet/Configuration page.)
Frequency	Frequency
Voltage deviation	Voltage deviation (Single Phase PDU)
/Unbalanced Current	/Unbalanced Current rate (3-Phase PDU)

Note: The font color of the above parameters is displayed according to the alarm threshold status. For the color change, refer to the “Electrical Parameter Color Bar”;

Line status

- 1) Display content: as shown in the figure, line current / line voltage status;

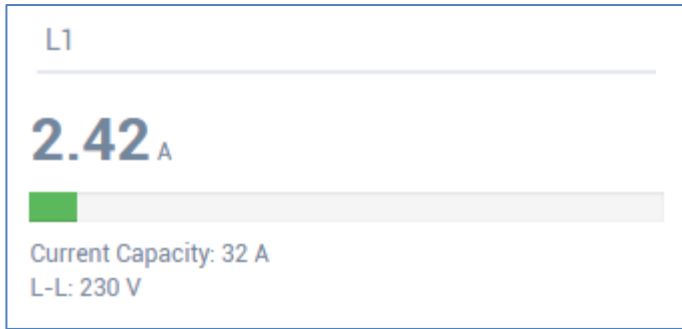

2) Current/voltage of different models, the letters are as follows:

项目 \ 机型	三相三角形	三相星形	单相
电流	L1,L2,L3	L1,L2,L3,N	L1
电压	L1-L2, L2-L3, L3-L1		L-L

Phase status

The single phase PDU displays only the status of one set of phases, and the 3-phase PDU displays three sets of phase states.;

ID	Phase Name	Voltage	Current	Active Power	Apparent Power	Power Factor	Active Energy	Status	Action
P1	L-N	232 V	0.00 A	0 W	0 VA	1.00	8728 Wh	Normal	<input type="button" value="Reset Active Energy"/>

Item	Description
ID	---
Phase Name	Name of Phase
Voltage	Voltage
Current	Current
Active Power	Active Power
Apparent Power	Apparent Power
Power Factor	Power Factor
Active Energy	Active Energy
Status	Normal/LowAlarm/LowWarning /HighWarning/HighAlarm
Action	<input type="button" value="Reset Active Energy"/>

Inlet history

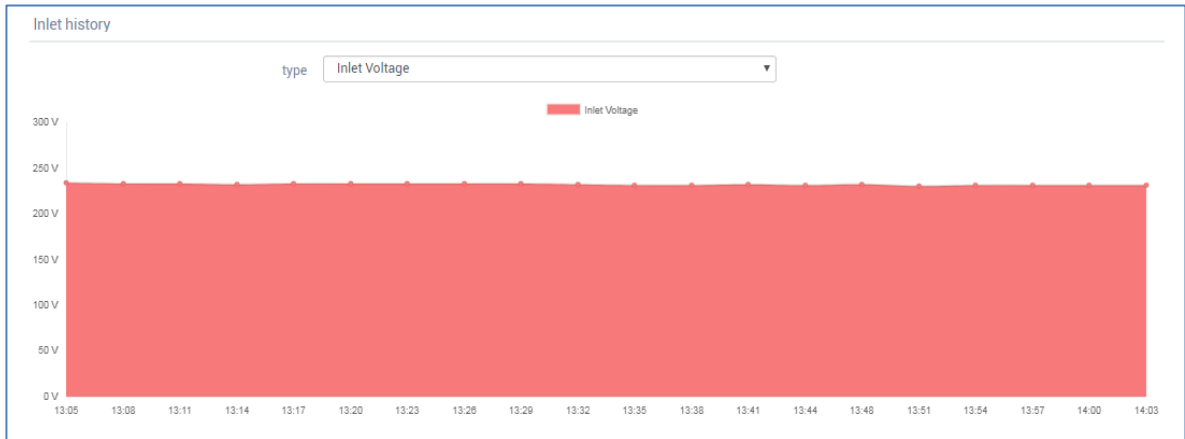

1) Save and update the curve every 2 minutes

Horizontal axis: the time axis of the last 2 hours, the origin is the first 2 hours, and Max is the current time point;

Vertical axis: automatically adjust the numerical range of the vertical axis according to the selected item and the electrical parameter of the last 2 hours;

Other: The mouse is placed on the curve to display the time point details.

2) Click type right side , Switch to other electrical parameter curves;

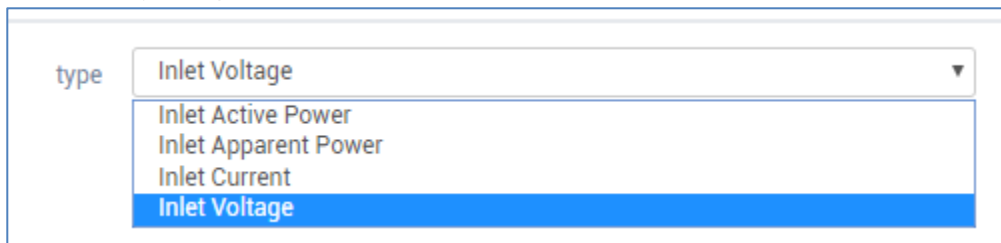

3) The display parameters of each model curve are as follows:

3phase Delta	3phase Y	Single phase
Inlet Active Power	Inlet Active Power	Inlet Active Power
Inlet Apparent Power	Inlet Apparent Power	Inlet Apparent Power
L1 Current	L1 Current	Inlet Current
L1-L2 Voltage	L1-N Voltage	Inlet Voltage
L2 Current	L2 Current	
L2-L3 Voltage	L2-N Voltage	
L3 Current	L3 Current	
L3-L1 Voltage	L3-N Voltage	
	N Current	

Configuration

Inlet Status
Configuration

Configure inlet thresholds

Inlet ID:

Inlet Type: SSEMCO 93-S3 2P+E

Inlet Name:

Active Energy: 0 Wh

Restore PDU Defined									
<input type="checkbox"/>	ID	Sensor Type	Hysteresis	Low Alarm	Low Warning	High Warning	High Alarm	SNMP Trap Notifications	Email Notifications
<input type="checkbox"/>	1	Inlet Active Power(kW)	0.1	-	-	5.152	5.888	✓	✓
<input type="checkbox"/>	2	Inlet Apparent Power(kVA)	0.1	-	-	5.152	5.888	✓	✓
<input type="checkbox"/>	3	Inlet Power Factor	0.02	0.7	0.8	-	-	✓	✓
<input type="checkbox"/>	4	Inlet Active Energy(kWh)	0.1	-	-	-	-	✓	✓
<input type="checkbox"/>	5	Inlet Line Frequency(Hz)	0.1	-	-	-	-	✓	✓
<input type="checkbox"/>	6	Inlet Current(A)	1	-	-	22.4	25.6	✓	✓
<input type="checkbox"/>	7	Inlet Voltage(V)	1	207	219	242	253	✓	✓

Cancel
Apply

Item	Description
Inlet ID	Enter ID, select other ID when multi-input
Inlet Type	Inlet Type
Inlet Name	Changeable, click Apply
Active Energy	Active Energy (Can be reset, click Reset , And in the pop-up dialog box, click "OK")
Threshold setting table	Threshold setting, refer to "Threshold Settings"

● Threshold Settings

The threshold refers to the highest or lowest value that can generate system alarm events. The threshold of the system can be configured by the user according to the actual application. According to the warning and alarm levels, it is divided into Low Alarm, Low Warning, and HighWarning. Early warning), HighAlarm (upper limit alarm), and Hysteresis (hysteresis difference) are set on the four thresholds. The proper threshold is configured to make the PDU better serve you.

The relationship between threshold and hysteresis::

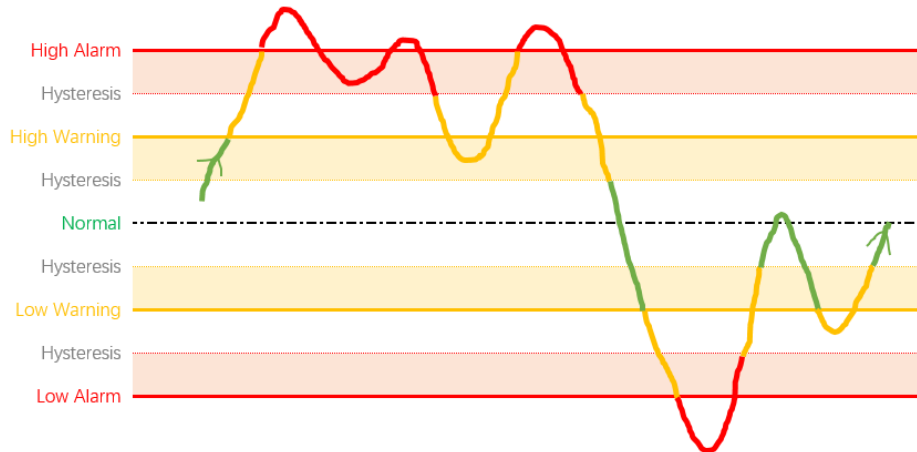

1. The green color is Normal, the red is Alarm, and the yellow is Warning.
2. Value: High Alarm > High Warning > Low Warning > Low Alarm;
3. When the value changes from small to large, when the High Warning or High Alarm is exceeded, the alarm of the corresponding level is triggered; but when the value falls from high to small and High Warning or High Alarm, when it is more than double the Hysteresis (return), the alarm of the corresponding level will be released;
4. Similarly, when the value changes from large to small, below Low Warning or Low Alarm, the corresponding level of alarm is triggered; but when the value rises from small to large from Low Warning or Low Alarm, it needs to be doubled Hysteresis (back When the difference is), the corresponding level of alarm will be released;

Threshold settings page:



Restore PDU Defined							
✓	ID	Sensor Type	Hysteresis	Low Alarm	Low Warning	High Warning	High Alarm
✓	1	Inlet Active Power(kW)	0.1	-	-	- ↺	5.888
✓	2	Inlet Apparent Power(kVA)	0.1	-	-	5.152	5.888
✓	3	Inlet Power Factor	0.02	0.7	0.8	-	-
✓	4	Inlet Active Energy(kWh)	0.1	-	-	-	-
✓	5	Inlet Line Frequency(Hz)	0.1	-	-	-	-
✓	6	Inlet Current(A)	1	-	-	22.4	25.6
✓	7	Inlet Voltage(V)	1	219 ↺ ⚠	219	242	253

Threshold settings rule:

The following requirements must be met when setting the threshold, otherwise an error message will be displayed, and the settings cannot be saved.;

- 1) The threshold input box only accepts numbers with the "-" character;
- 2) Lower Alarm rule:
 - Lower Alarm - hysteresis >= Min;
 - Lower Alarm + hysteresis <= Lower Warning;

- 3) Lower Warning rule:
 - Lower Warning – hysteresis >= Min;
 - Lower Alarm + hysteresis <= Lower Warning;
 - Lower Warning + 2 times hysteresis <= High Warning;
- 4) High Warning rule:
 - High Warning – hysteresis >= Min;
 - Lower Warning + 2 times hysteresis <= High Warning;
 - High Warning + hysteresis <= High Alarm;
- 5) High Alarm rule:
 - High Alarm – hysteresis >= Min;
 - High Warning + hysteresis <= High Alarm;
 - High Alarm + hysteresis <= Max;
- 6) Enter "-" to not alert or alert the value.

Note: Click  to restore to the value before modification; when the threshold setting does not meet the rule, the prompt " " will appear.

Threshold restored to default

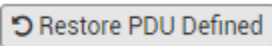
- 1) Check the threshold you want to restore, or click the confirmation box before the ID in the upper left corner (select all)  ID ;
- 2) Click  button, In the pop-up dialog box, click the "OK" button to return to the factory defaults.

● **Over-Current Protectors info**

This page allows you to view and configure the status and related parameters of the overcurrent protector;

OCP Status

List of Over Current Protectors status							
ID	OCP Name	Type	State	Current	Status	Protected Outlets	Phases
B1	Circuit Breaker B1	Circuit Breaker	Closed	0.00 A	<input type="text" value="16A"/>	1,2,3,4,5,6,7,8,9,10,11,12	L-N
B2	Circuit Breaker B2	Circuit Breaker	Closed	0.00 A	<input type="text" value="16A"/>	13,14,15,16,17,18,19,20,21,22,23,24	L-N

OCP info:

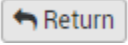
Item	Description
ID	---
OCP Name	OCP name, click to enter the OCP page, view details, change the OCP name, view Over current protector history, Click the right upper  to return.
Type	OCP type
State	OCP on/off state

Current	OCP loading
Status	OCP load current status (the color of the status color bar, such as the "Line status" requirement of "Overview");
Protected Outlets	OCP protected output socket ID
Phases	OCP's phase

Congfiguration

Over Current Protector Settings

Restore PDU Defined

<input type="checkbox"/>	ID	OCP Name	Type	hysteresis	Current High Warning	Current High Alarm	SNMP Trap Notifications	Email Notifications
<input type="checkbox"/>	B1	Circuit Breaker B1	Circuit Breaker	1	11.2 A	12.8 A	<input checked="" type="checkbox"/>	<input checked="" type="checkbox"/>
<input type="checkbox"/>	B2	Circuit Breaker B2	Circuit Breaker	1	11.2 A	12.8 A	<input checked="" type="checkbox"/>	<input checked="" type="checkbox"/>

OCP configuration :

Item	Description
ID	---
OCP Name	OCP name, modify the OCP name and click the "Apply" button to change
Type	OCP type
hysteresis	OCP Current difference value setting (after modification, click Apply to take effect)
Current High Warning	OCP Current upper limit warning value setting (after modification, click Apply to take effect)
Current High Alarm	OCP Current upper limit alarm value setting (after modification, click Apply to take effect)
SNMP Trap Notifications	OCP SNMP Trap notice (after modification, click Apply to take effect)
Email Notifications	OCP mail notice (after modification, click Apply to take effect)

Note: Threshold setting reference: [Threshold setting rule](#).

● Outlets

Outlet Status

Selected Group: all [Remove]

Control Actions: On Off Cycle Create Group

<input type="checkbox"/>	ID	Outlet Name	Socket Type	Current	Active Power	Power Factor	State	Status	Action
<input type="checkbox"/>	01	Outlet 01	IEC320 C13	0.00 A	0 W	1.00	On	Normal	<input type="checkbox"/> Cycle
<input type="checkbox"/>	02	Outlet 02	IEC320 C13	0.00 A	0 W	1.00	On	Normal	<input type="checkbox"/> Cycle
<input type="checkbox"/>	03	Outlet 03	IEC320 C13	0.00 A	0 W	1.00	On	Normal	<input type="checkbox"/> Cycle
<input type="checkbox"/>	04	Outlet 04	IEC320 C13	0.00 A	0 W	1.00	On	Normal	<input type="checkbox"/> Cycle
<input type="checkbox"/>	05	Outlet 05	IEC320 C13	0.00 A	0 W	1.00	On	Normal	<input type="checkbox"/> Cycle
<input type="checkbox"/>	06	Outlet 06	IEC320 C13	0.00 A	0 W	1.00	On	Normal	<input type="checkbox"/> Cycle
<input type="checkbox"/>	07	Outlet 07	IEC320 C13	0.00 A	0 W	1.00	On	Normal	<input type="checkbox"/> Cycle
<input type="checkbox"/>	08	Outlet 08	IEC320 C13	0.00 A	0 W	1.00	On	Normal	<input type="checkbox"/> Cycle
<input type="checkbox"/>	09	Outlet 09	IEC320 C13	0.00 A	0 W	1.00	On	Normal	<input type="checkbox"/> Cycle
<input type="checkbox"/>	10	Outlet 10	IEC320 C13	0.00 A	0 W	1.00	On	Normal	<input type="checkbox"/> Cycle
<input type="checkbox"/>	11	Outlet 11	IEC320 C13	0.00 A	0 W	1.00	On	Normal	<input type="checkbox"/> Cycle
<input type="checkbox"/>	12	Outlet 12	IEC320 C13	0.00 A	0 W	1.00	On	Normal	<input type="checkbox"/> Cycle

Outlet group operation

1、 Select group: Click the group box, pop-up menu, select group;

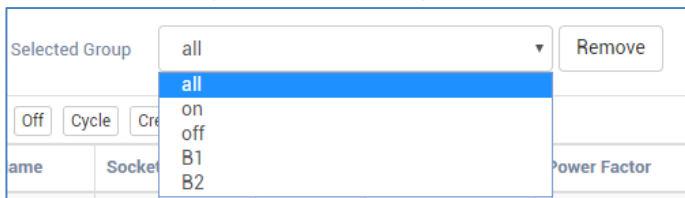

2、 Create a group:

1) Click the checkbox to the left of the corresponding ID (the first checkbox is: Select All), and select the outlets of the group;

Control Actions: On Off Cycle Create Group

<input checked="" type="checkbox"/>	ID	Outlet Name	Socket Type	Current	Active Power	Power Factor	State	Status
<input checked="" type="checkbox"/>	01	Outlet 01	IEC320 C13	0.00 A	0 W	1.00	On	Normal
<input checked="" type="checkbox"/>	02	Outlet 02	IEC320 C13	0.00 A	0 W	1.00	On	Normal
<input checked="" type="checkbox"/>	03	Outlet 03	IEC320 C13	0.00 A	0 W	1.00	On	Normal
<input checked="" type="checkbox"/>	04	Outlet 04	IEC320 C13	0.00 A	0 W	1.00	On	Normal
<input checked="" type="checkbox"/>	05	Outlet 05	IEC320 C13	0.00 A	0 W	1.00	On	Normal

2) Click Control Actions: **Create Group** button;

3) In the pop-up dialog box, enter the group name (Group Name), click the "Apply" button, the group creation is completed.

3、 Remove the group: If you want to remove the group, first select the group in the drop-down menu of the group, the Outlet list will be displayed according to the selected group, click the "Remove" button, click on the pop-up dialog box OK" to remove the corresponding group;

Note: Only the user-defined group can be removed, the system preset grouping, can not be removed;

4、 Batch operation: switch operation can be performed in batch according to the selected Outlet

Button	Description
On	The action of opening the selected outlet, invalidating the locked outlet, and the outlet whose status is open or in the cycle
Off	The action of closing the selected outlet, invalidating the locked outlet, and the outlet whose state is closed or being cycled
Cycle	The action of restarting (selecting and then opening) the selected outlet, invalidating the locked outlet, and the outlet whose status is closed or being cycled
Create Group	Create a custom group for the selected outlet. Click this button to pop up a dialog box to name the group. You can then select this group in the Group.

Outlet Status

ID	Outlet Name	Socket Type	Current	Active Power	Power Factor	State	Status	Action
01	Outlet 01	IEC320 C13	0.00 A	0 W	1.00	On	Normal	
02	Outlet 02	IEC320 C13	0.00 A	0 W	1.00	On	Normal	
03	Outlet 03	IEC320 C13	0.00 A	0 W	1.00	On	Normal	
04	Outlet 04	IEC320 C13	0.00 A	0 W	1.00	On	Normal	
05	Outlet 05	IEC320 C13	0.00 A	0 W	1.00	On	Normal	
06	Outlet 06	IEC320 C13	0.00 A	0 W	1.00	On	Normal	
07	Outlet 07	IEC320 C13	0.00 A	0 W	1.00	On	Normal	
08	Outlet 08	IEC320 C13	0.00 A	0 W	1.00	On	Normal	
09	Outlet 09	IEC320 C13	0.00 A	0 W	1.00	On	Normal	
10	Outlet 10	IEC320 C13	0.00 A	0 W	1.00	On	Normal	
11	Outlet 11	IEC320 C13	0.00 A	0 W	1.00	On	Normal	
12	Outlet 12	IEC320 C13	0.00 A	0 W	1.00	On	Normal	

Outlet list:

Item	content	Description
Outlet Name	Click Outlet Name	outlet
State		Outlet on
		Outlet off
		Outlet on and lock
		Outlet off and lock
Status	Normal	Outlet on and normal
	Disabled	Outlet disabled
		Outlet in low alert state, some parameters exceed the warning threshold
		Outlet in low alarm state, some parameters exceed the alarm threshold
		outlet in upper alert state, some parameters exceed the alarm threshold
		outlet in upper alarm state, some parameters exceed the alarm threshold
Action		The control is operational, currently open and can be closed
		The control is operational and is currently off. It can be turned on.
		The action of restarting the outlet (turning off and then opening), invalidating the locked outlet, and the outlet whose status is closed or being cycled

Outlet Detail

Outlet Status Configuration Thresholds

Outlet 01 Return

Action FF Cycle

State Off 234 V 50.0 Hz Power Factor 1.00 Active Energy 0 Wh Reset Energy	Current 0.00 A Capacity: 10 A	Active Power 0 W Capacity: 2300 W	Apparent Power 0 VA Capacity: 2300 VA
--	--	--	--

Outlet information

Outlet ID 01

Socket Type IEC320 C13

Over current protector Circuit Breaker B1 status

Phase L-N status

Inlet Inlet I1 status

Outlet settings

Locked / No Control ON

Name

Extra On Delay(sec)

Wake Up State

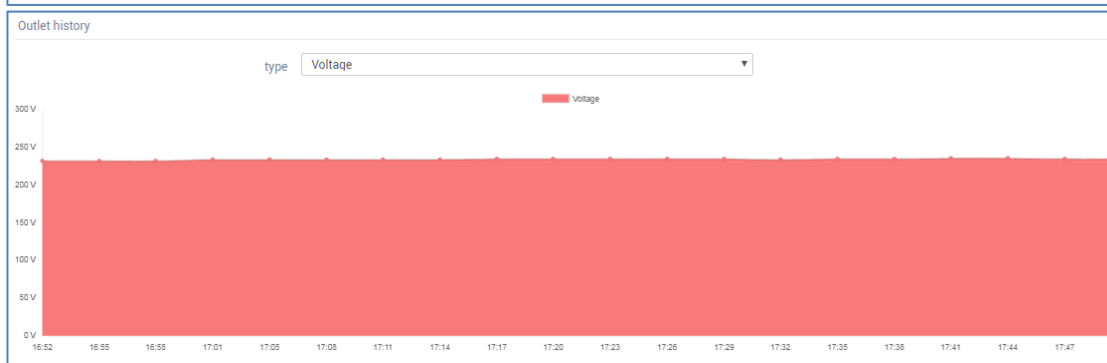

Configure thresholds

Restore PDU Defined

ID	Sensor Type	Hysteresis	Low Alarm	Low Warning	High Warning	High Alarm	SNMP Trap Notifications	Email Notifications
1	Current(A)	1	-	-	7	8	<input checked="" type="checkbox"/>	<input checked="" type="checkbox"/>
2	Voltage(V)	1	207	219	242	253	<input checked="" type="checkbox"/>	<input checked="" type="checkbox"/>
3	Active Power(kW)	0.1	-	-	1.61	1.84	<input checked="" type="checkbox"/>	<input checked="" type="checkbox"/>
4	Apparent Power(kVA)	0.1	-	-	1.61	1.84	<input checked="" type="checkbox"/>	<input checked="" type="checkbox"/>
5	Power Factor(%)	0.02	0.7	0.8	-	-	<input checked="" type="checkbox"/>	<input checked="" type="checkbox"/>
6	Active Energy(kWh)	0.1	-	-	-	-	<input checked="" type="checkbox"/>	<input checked="" type="checkbox"/>
7	Line Frequency(Hz)	0.1	-	-	-	-	<input checked="" type="checkbox"/>	<input checked="" type="checkbox"/>

[Cancel](#) [Apply](#)

item	Description
Outlet 01 (ID): includes outlet action (switch, restart), switch status, voltage, frequency, power factor, active power, and power reset	
Return	Back to power/outlet/status
Action	Can perform on/off/Cycle operation on the outlet
State	Outlet state, on/off
Reset Energy	Reset Energy
Electrical parameters	Display: Voltage/ Frequency/Power Factor/ Active Energy Color bar display: Current/Active Power/Apparent Power
Outlet information	
Outlet ID	-
Socket Type	Socket Type
Over current protector	OCP of outlet, click status to jump to: Power/over-Current Protector/OCP status
Phase	Phase of Outlet, click status to jump to: power/inlet/status
Inlet	Inlet of Outlet, click status to jump to: power/inlet/status
Outlet settings	
Locked / No Control	Locked (default is not locked, click the button to change, take effect immediately)
Name	Outlet name (After modification, click "Apply" to take effect)
Extra On Delay(sec)	Outlets power-on interval (Refer to "Delay Time Setting Rules")
Wake Up State	The state of the boot outlet (default last, can be set to: on / off)
Outlet history: The historical curve of the electrical parameters of the outlet, refer to "Power/Inlet's Inlet history"	
Configure thresholds : Set the threshold of all electrical parameters of a single outlet, refer to " Threshold Settings "	

Configuration

Global Outlet Options: outlets general configuration

Global Outlet Options

Sequence Interval Unit: Seconds

Cycle Delay Unit: Seconds

item	Description
Sequence Interval	Outlets power-on interval, default 1s, range is 0-15s, refer to "delay time setting rules"
Cycle Delay	When restarting the (Cycle) outlet, the delay is turned on, the default is 15s, the range is 5-900s. Refer to the "Delay Time Setting Rule".

Unit Outlet Options: Single outlet setting

Unit Outlet Options

Selected Group

Reset Active Energy

<input type="checkbox"/>	ID	Outlet Name	Socket Type	Active Energy	Extra On Delay(sec)	Wake Up State	Locked/No Control	SNMP Trap Notifications	Email Notifications
<input type="checkbox"/>	01	Outlet 01	IEC320 C13	0 Wh	0 s	LAST	<input checked="" type="checkbox"/>	<input checked="" type="checkbox"/>	<input checked="" type="checkbox"/>
<input type="checkbox"/>	02	Outlet 02	IEC320 C13	0 Wh	0 s	LAST	<input type="checkbox"/>	<input checked="" type="checkbox"/>	<input checked="" type="checkbox"/>
<input type="checkbox"/>	03	Outlet 03	IEC320 C13	0 Wh	0 s	LAST	<input type="checkbox"/>	<input checked="" type="checkbox"/>	<input checked="" type="checkbox"/>

ITEM	DESCRIPTION
Selected Group	Selected Group
Reset Active Energy	Reset Active Energy which is selected
ID	Outlets ID
Outlet Name	Outlet Name
Socket Type	Socket Type
Active Energy	Active Energy (Resettable)
Extra On Delay(sec)	The power-on interval of the outlets is valid when the interval is greater than or equal to the interval. Otherwise, it is the sequence interval. Refer to the delay setting rule (can be set).
Wake Up State	The state of the boot outlet (default last, can be set)
Locked/No Control	Lock/unlock outlet (default unlock state, configurable)
SNMP Trap Notifications	SNMP Trap notification (default on, configurable)
Email Notifications	Email notification (default is on, can be set)

Note: After the parameters are modified, click Apply to take effect.

Explanation of Outlet power-on interval and delay time:

- 1) Sequence Interval: When two or more outlets perform the power-on action at the same time, or the power-on action interval is shorter than the set time, the interval time of the power-on interval is set according to the time set by this time. Power-on;
- 2) Cycle Delay: After the Cycle is executed, the outlet is powered off. After the set time, the outlet is powered on.
- 3) Extra On Delay: The outlet that sets this parameter delays the set time after power-on, and the next execution power-up outlet can be operated; during this period, all outlets are allowed to perform power-off action. Power-on action is not allowed; if the setting time is lower than the sequence interval setting time, it will be invalid. Set the time according to the sequence interval.

eg:

- 1) Setting: Sequence Interval(T1) : 2s,
 Cycle Delay (T2) : 15s,
 Extra On Delay(T3) : Outlet01, 02, 03 all are 0;

Condition: The initial power-on of the whole machine;

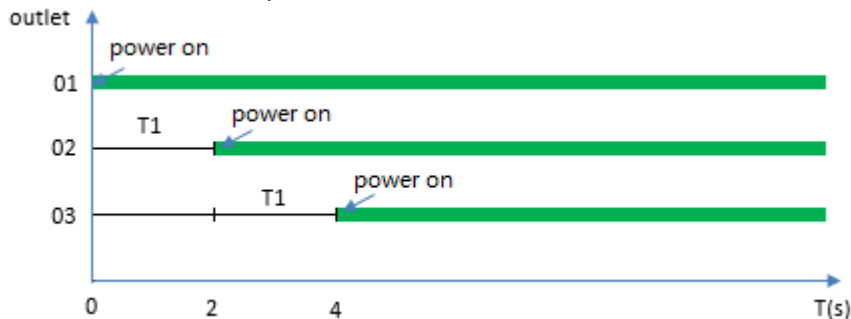

Power-on sequence: outlet 01 power-on time: 0s,
 outlet 02 power-on time: 2nd second,
 outlet 03 power-on time: 4th second.

- 2) setting: Sequence Interval(T1) : 2s,
 Cycle Delay (T2) : 15s,
 Extra On Delay(T3) : Outlet01, 03 is 0, Outlet02 is 5;

Condition: The initial power-on of the whole machine;

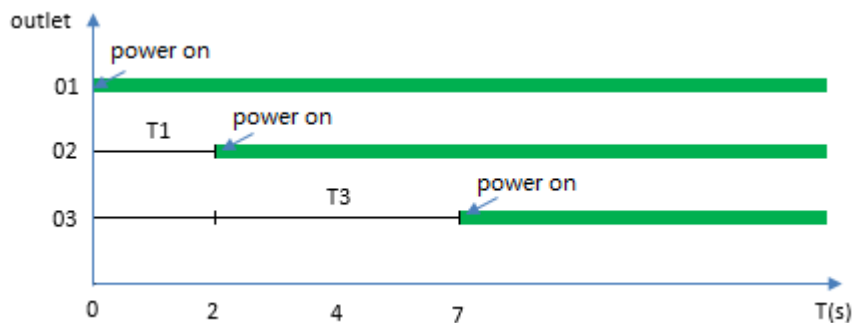

Power-on sequence: outlet 01 power-on time: 0s,
 outlet 02 power-on time: 2nd second,
 outlet 03 power-on time: 7th second.

- 3) Setting: Sequence Interval(T1) : 2s,
 Cycle Delay(T2) : 15s,
 Extra On Delay(T3) : Outlet01, 02, 03 are 0;

Condition: Batch restart operation;

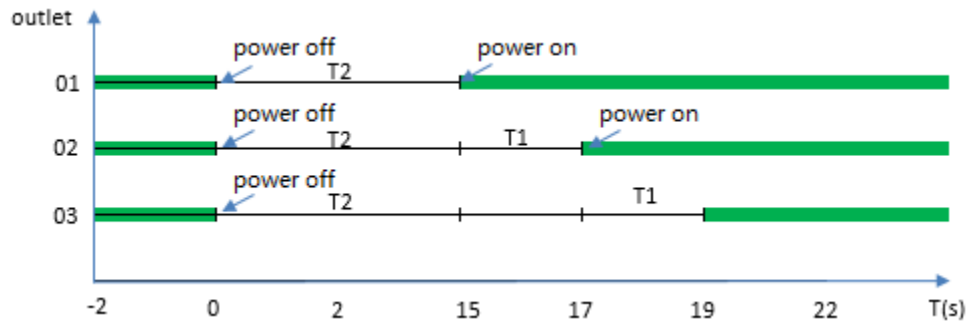

Power-on sequence: outlet01/02/03, when in 0s, off at the same time,
 outlet 01 power-on time: 15th second,
 outlet 02 power-on time: 17th second,
 outlet 03 power-on time: 19th second.

- 4) Setting: Sequence Interval(T1) : 2s,
 Cycle Delay(T2) : 15s,
 Extra On Delay(T3) : Outlet01, 03 are 0, Outlet02 is 5;

Condition: Batch restart operation

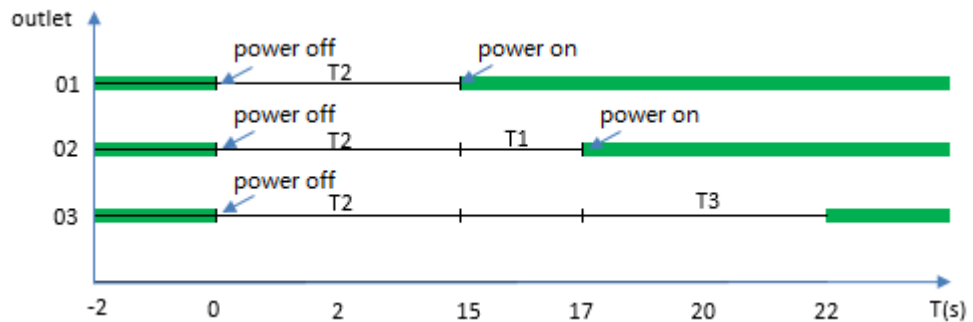

Power-on sequence: outlet01/02/03, when 0s, off at the same time,
 outlet 01 power-on time: 15th second,
 outlet 02 power-on time: 17th second,
 outlet 03 power-on time: 22nd second.

Thresholds setting

Outlet Status
Configuration
Thresholds

Outlet Thresholds

Type of Sensors Current(Amp) ▼

Selected Group all ▼

Reset PDU Defined

	ID	Outlet Name	Socket Type	Hysteresis	Low Alarm	Low Warning	High Warning	High Alarm
<input checked="" type="checkbox"/>	01	Outlet 01	IEC320 C13	1	-	-	7	8
<input checked="" type="checkbox"/>	02	Outlet 02	IEC320 C13	1	-	-	7	8
<input checked="" type="checkbox"/>	03	Outlet 03	IEC320 C13	1	-	-	7	8
<input checked="" type="checkbox"/>	04	Outlet 04	IEC320 C13	1	-	-	7	8

Outlet Thresholds: Outlet threshold setting

ITEM	DESCRIPTION
Type of Sensors	Select parameter
Selected Group	Select group
Reset PDU Defined	Restore factory defaults
Threshold setting table	outlets Threshold setting table

Reference: Threshold setting.

4.8 Peripherals monitoring and configuration

View and configure ambient temperature and humidity sensors and other peripherals on this page;

- **Sensors**

View the collected ambient temperature and humidity sensor acquisition value;

Temperature Sensor Status

Temp_Sensor_T1 Edit

28.43°C

Range: -20 ~ 75 °C
Position:

--

--°C

Range: -- ~ -- °C
Position: --

Humidity Sensor Status

Humid_Sensor_H1 Edit

57.6 %RH

Range: 0 ~ 100 %RH
Position:

--

-- %RH

Range: -- ~ -- %RH
Position: --

Water Sensor Status

Water_Sensor_W1

Uninstall

Position:

ITEM	DESCRIPTION
Temperature Sensor Status	
Temp_Sensor_T1	Sensor Name
Edit button	Edit button, click to edit the name, position, and threshold of the sensor (refer to <u>"Threshold Settings"</u>)
Temperature Value	Current Temperature
Temperature color bar	Color change, refer to "temperature and humidity color bar"
Range	Temperature measurement range
Position	Sensor installation location
Humidity Sensor Status	
Humid_Sensor_H1	Sensor Name
Edit Button	Edit button, click to edit the name, position, and threshold of the sensor (refer to <u>"Threshold Settings"</u>)
Humidity value	Current Humidity
Humidity color bar	Color change, refer to "temperature and humidity color bar"
Range	Humidity measurement range

Position	Sensor installation location
Water Sensor Status	Supported after V1.3
Contact Sensor Status	Supported after V1.3

4.9 Configuration

This page provides system and network configuration but requires administrator group permissions.

- **System**

System information and system options, Front-Panel, date and time configuration.

About:

System information	
Model	PU-241HC-AC56E
Serial Number	MOD_D1
Board ID	18J0020
Rating	6.4~7.7kVA 200~240V 32A 50/60Hz
Firmware Version	National Day Edition(1.1.13)
Hardware Revision	A01
Build Info	Rev 01, Oct 01 2018
Uptime	3 days 4 hours 12 minutes 23 seconds

1. Choose Configuration > System >About tab.
2. System information in the following fields.

Field	Description
Model	Model name
Serial Number	Device serial number
Board ID	Motherboard ID
Rating	Equipment rating
Firmware Version	Firmware version
Hardware Revision	hardware version
Build Info	Production information and version
Uptime	This startup time

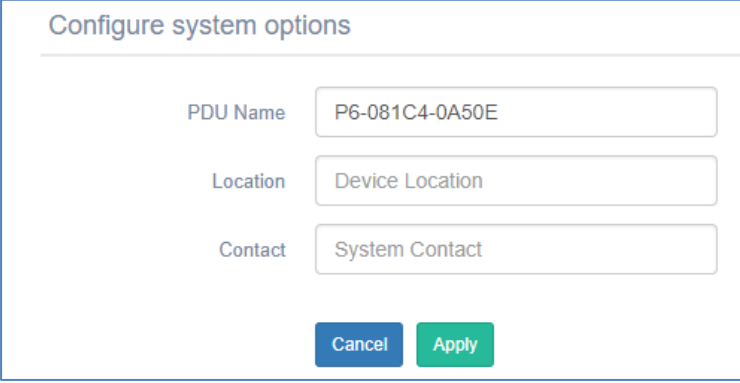
About configuration system options:

Configure system options

PDU Name P6-081C4-0A50E

Location Device Location

Contact System Contact

Cancel Apply

1. Choose Configuration > System > About tab.
2. Edit the PDU Name in the Configure system options (the PDU name, default is the model name, up to 32 characters), Location (placement, default is empty, up to 64 characters), Contact (contact information).
3. Click Apply to save it.

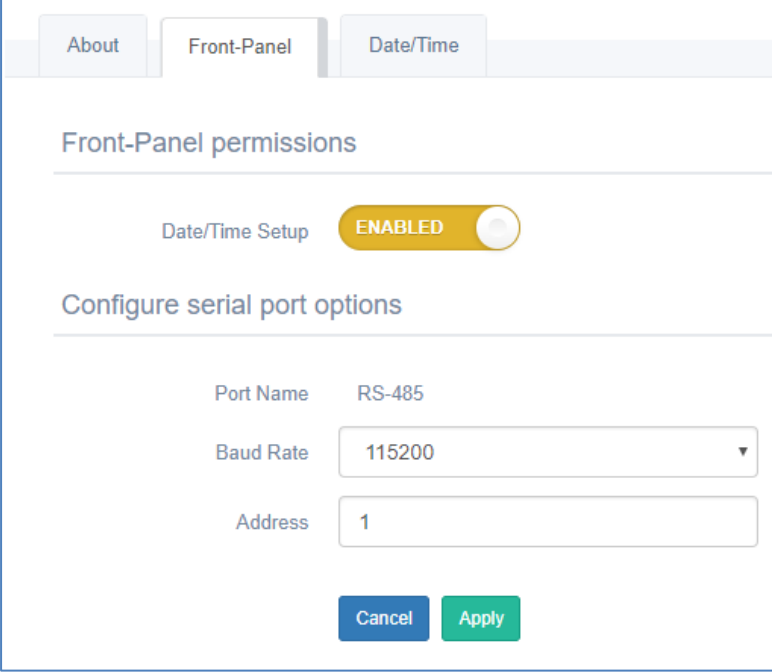
Configuring the Front-Panel option:

About Front-Panel Date/Time

Front-Panel permissions

Date/Time Setup ENABLED

Configure serial port options

Port Name RS-485

Baud Rate 115200

Address 1

Cancel Apply

1. Choose Configuration > System > Front-Panel tab.
2. Choose Front-Panel permissions > Date/Time Setup field to enable/disable the date and time setting permissions of the Front-Panel.
3. Select Baud Rate and enter Address in Configure serial port options to configure the Front-Panel RS-485 interface.
4. Click Apply to save it.

Configuring Date/Time:

The screenshot displays the 'Date/Time' configuration interface. It features three tabs: 'About', 'Front-Panel', and 'Date/Time'. The 'Date/Time' tab is active, showing the following settings:

- Date/Time Settings:**
 - Time Zone:** A dropdown menu currently set to 'UTC'.
 - Date and Time:** A text field showing '2018-10-23 10:22:37' with a calendar icon to its right.
 - Synchronize with NTP Server:** A toggle switch that is currently turned on, labeled 'ENABLED'.
- NTP Server Settings:**
 - Primary Host:** A text input field containing '0.openwrt.pool.ntp.org'.
 - Secondary Host:** A text input field containing '1.openwrt.pool.ntp.org'.

At the bottom of the configuration area, there are two buttons: 'Cancel' (blue) and 'Apply' (green).

1. Choose Configuration > System > Date/time tab.
2. Select the Time Zone, Date and Time, Synchronize with NTP Server fields in the Date/Time Settings option, if Synchronize with NTP Server is configured as Enable enables the device to automatically synchronize time with the server address configured in the NTP Server Settings option.
3. Enter the Primary Host and Secondary Host in the NTP Server Settings option.
4. Click Apply to save it.

- **Network**

This page shows device network information and configures Network, Email, SNMP, syslog server

Network configuration information:

Network configuration	
State	Static
Link	Up
Speed	100 Mbps
Duplex	Full
Negotiation	Auto
Ethernet MAC Address	00:19:4c:aa:00:56
Autocfg IPv6 Address	fe80::219:4cff:feaa:56/64
Stateless DHCPv6 Address	
IPv4 Address	192.168.0.181
IPv4 Subnet Mask	255.255.255.0
IPv4 Gateway	192.168.0.1
Primary DNS	114.114.114.114
Secondary DNS	8.8.8.8

1. Choose Configuration > Network >DHCP/IP tab.
2. Network configuration information in the following fields:

Field	Description
State	IP access mode (static: static, DHCP: Dynamic)
Link	Current Ethernet connection status
Speed	NIC speed
Duplex	Multiplexing mode (full: full duplex)
Negotiation	Coordination mechanism (auto: auto-negotiation)
Ethernet MAC Address	MAC address
Autocfg IPv6 Address	Automatically assign an IPv6 address
Stateless DHCPv6 Address	Stateless DHCPv6 address
IPv4 Address	IPv4 address
IPv4 Subnet Mask	IPv4 subnet mask
IPv4 Gateway	IPv4 gateway

Primary DNS	Primary DNS server address
Secondary DNS	Secondary DNS server address

Configuring IPv4/IPv6:

Configure static IPv4/IPv6 Settings

IPv6 Address

IPv6 Gateway

IPv4 Address

IPv4 Subnet Mask

IPv4 Gateway

Primary DNS

Secondary DNS

Configure DHCP settings

DHCP ENABLED

FQDN DISABLED

Static Address Fallback ENABLED

1. Choose Configuration > Network >DHCP/IP tab.
2. Enter the fields for the Configure static IPv4/IPv6 Settings option.
3. Enable DHCP in Configure DHCP settings if you need to dynamically IP.
4. Click Apply to save it.

Configuring Email:

Email/SMTP Options

SMTP Host

SSL Enable

SMTP Port

SMTP Authentication

SMTP Username

SMTP Password

'From' Address

Primary 'To' Address

Secondary 'To' Address

1. Choose Configuration > Network > SMTP/Email tab.
2. Enter the Email configuration in Email/SMTP Options.

Notification Options

Event Notifications ENABLED

Access Events

Config Events

Outlet Control Events

User Administration Events

Device Events

System Events

Power Events

Sensor Events

3. If you need to send an event reminder via email, enable the Event Notifications field in the Notification Options.
4. Click Apply to save it.
5. Email/SMTP Options in the following fields:

Field	Description
SMTP Host	SMTP host address
SSL Enable	Enable ssl encryption

SMTP Port	SMTP server port
SMTP Authentication	SMTP server authentication
SMTP Username	SMTP server username
SMTP Password	SMTP server password
'From' Address	Email sender address
Primary 'To' Address	Primary email recipient address
Secondary 'To' Address	Secondary email recipient address

Configuring SNMP:

See [6. USING SNMP](#)

Configuring syslog:

External system log server

External system log server port Default: 514

Log output level ▼

Protocol ▼

1. Choose Configuration > Network > Syslog tab.
2. Enter the External system log server address, External system log server port, Log output level, Protocol field.
3. Click Apply to save it.

4.10 User Management

- **Users**

Add, delete, change, and check the user and its configuration, only the administrator group permission operation.

Edit user configuration:

List of users

ID	User Name	Full Name	Email	Access Level	Status	Action
1	aaa	aaa		User	Enable	<input type="button" value="Edit"/> <input type="button" value="Delete"/>
2	test	tesss	123456789@qq.com	User	Enable	<input type="button" value="Edit"/> <input type="button" value="Delete"/>

1. Choose User Management > Users.

2. Click Add to add the user, Edit to edit the user configuration, and Delete to delete the user.

User edit , Set new password, access level, and monitoring rights

*User Name

Full Name

Password

Verify Password

Email

Telephone Number

Web Session Timeout minutes

Cli Session Timeout minutes

Status ENABLED

Setup user preferences

Temperature Unit

Length Unit

Pressure Unit

User being assigned access rights

Access Level

Console

SSH

Web

Type	ID	Name	Access Type
Outlet	01	Outlet 01	No Access
Outlet	02	Outlet 02	No Access
Outlet	03	Outlet 03	No Access
Outlet	04	Outlet 04	No Access
Outlet	05	Outlet 05	No Access
Outlet	06	Outlet 06	No Access
Outlet	07	Outlet 07	No Access
Outlet	08	Outlet 08	No Access
Outlet	09	Outlet 09	No Access

3. After adding or editing the user configuration, click apply at the bottom of the page to save the configuration, or click cancel or return at the top of the page to cancel the save and exit.
4. Type values in the following fields.

Field	Description
User edit	
User Name	User name (required)
Full Name	User full name, up to 64 characters
Password	Password, 6-32 characters, such as not to change the password is empty
Verify Password	Confirm password
Email	User email address
Telephone Number	User phone number
Web Session Timeout	Web login timeout (in minutes)
Cli Session Timeout	Command line login timeout (in minutes)
Status	Whether to enable
Setup user preferences	
Temperature Unit	Temperature display unit, °C/°F optional, default °C
Length Unit	Length display unit, Meter/Feet optional, default Meter
Pressure Unit	Pressure display units, Pascal / Psi optional, defaults Pascal
User access rights	
Access Level	Access levels (normal user, administrator)
Console	Is it possible to access the serial console?
SSH	Is it possible to access the network command line?
Web	Is it possible to access the web management page?

Note:

1. The administrator has all access rights, and users can assign rights through the User Management > Users > add/edit > User being assigned access rights page.

Type	ID	Name	Access Type
Outlet	01	Outlet 01	View ▼
Outlet	02	Outlet 02	View & Configuration ▼
Outlet	03	Outlet 03	View & Configuration & Control ▼
Outlet	04	Outlet 04	No Access ▼

2. Different users can be assigned different permissions for each output socket. The permission types include no access rights and a combination of view, configuration, and control.

- **User preference**

This page sets the preferences of the current user.

Set user preferences:

1. Choose User Management > User Preference.
2. Modify the Setup user preference value
3. Click Apply to save it.
4. Type values in the following fields.

Field	Description
Web Session Timeout	Web login timeout (in minutes)
Cli Session Timeout	Command line login timeout (in minutes)
language	The default language of the page
Temperature Unit	Temperature display unit, °C/°F optional, default °C
Length Unit	Length display unit, Meter/Feet optional, default Meter
Pressure Unit	Pressure display units, Pascal / Psi optional, defaults Pascal

- **Change Password**

This page allows you to change the current user password.

Change current user password:

1. Choose User Management > Change Password.
2. Enter Current Password, New Password (6-32 characters), and Verify New Password.
3. Click Apply to save it.

4.11 Maintenance

- **Ping**

Web interface integrated ping tool for network connectivity test;

1. Choose Maintenance > Ping
2. Enter the domain name or ip address to be tested in the Host Name or IP Address field.
3. Click the ping button to send 4 ICMP messages.

- **Upgrade Firmware**

Contact Gelupower for the latest firmware for firmware upgrades, Administrator rights are required to upgrade the firmware.

Warning: Do not disconnect the power of the device or plug and unplug the device accessories during the firmware upgrade!

Upgrade Firmware:

1. Choose Maintenance > Upgrade Firmware.
2. Click the Browse... button and select the firmware file you want to upgrade.
3. Click the Upgrade button.

4. Select Yes on the “Confirm to Upgrade?” page.
5. After the upgrade is successful, the “Upgrade successful” dialog box will pop up. The update may take a few minutes.

Note:

1. The firmware file is a file with the “.ipk” suffix; Windows system recommends deselected the File Browser > Tools > Folder Options > View > Hide Extensions for Known File Type checkbox to determine the file suffix “.ipk”.

2. After the file transfer progress bar is full, there is still a firmware package action. Please wait patiently for the upgrade to complete.

- **Backup/Restore**

The Backup/Restore page provides import and export of device configurations and factory reset operations. Access to this page requires administrator privileges.

Export configuration:

1. Choose Maintenance > Backup/Restore.
2. Choose Export system configuration file > Exclude the following Contains Outlet group config, Sensor config, Network config, User config etc. Options to be excluded. You can also disable the Exclude the following field to export all configurations.
3. Click the Export button in the System configuration file field to select a storage location to save the configuration file.

Import configuration:

1. Choose Maintenance > Backup/Restore.

2. Click the Browse... button in the Import system configuration > System configuration file field to select the configuration file you want to import.
3. Click the Import button.
4. Select Yes on the "Confirm to import? " page.
5. After the import is successful, you will be prompted with "Import successful, please wait for the system to restart. "
6. Wait for the system to restart.

Note: When importing the configuration of other devices, the device model and software version must be consistent.

Restore factory defaults:

The screenshot shows a web interface titled "Restore factory default configuration". At the top right is a "Restore" button. Below it is a toggle switch for "Exclude the following" which is currently turned on (labeled "ENABLED"). Underneath are four checkboxes: "Restore network config" (checked), "Cleanup events" (unchecked), "Cleanup history" (unchecked), and "Cleanup user" (unchecked).

1. Choose Maintenance > Backup/Restore.
2. Choose Restore factory default configuration > Exclude the following: Restore network config, Cleanup events, Cleanup history, Cleanup user etc. Options to be excluded. You can also close the Exclude the following field to restore all configurations.
3. Click the Restore button.
4. Select Yes on the "Confirm to restore? " page.
5. The recovery success will pop up the Restore Successful prompt.

Note:

1. If the Restore network config option is not excluded, the network configuration will be reset, and the network card will be reset when Restore factory defaults. Please wait for the NIC to restart successfully and then re-login the webpage using the default ip configuration (192.168.10.127/24).

2. If the Cleanup user option is not excluded, all users except admin will be cleared when Restore factory defaults. Please use the admin user to log in again.

3. Restore factory defaults will clear the original configuration, please be cautious.

● **History Data Files**

The Historical Data File page provides the user to download the PDU control and acquisition unit historical data (voltage, current, power factor, etc.).

Download historical data files:

History data files

Selected history class Unit ▼

Selected object ID U1 ▼

Index	File Name	Size(Byte)
0	U1_20181023.csv	2221
1	U1_20181022.csv	10794
2	U1_20181021.csv	16674

1. Choose Maintenance > History Data Files.
2. Choose Selected history class field.
3. Choose Selected object ID field.
4. Click on the file name or Download All to download individual or packaged downloads of all data files.
5. Selected history class optional values in the following fields.

Field	Description
Unit	PDU history apparent power, power utilization, total energy data.
Inlet Cord	Inlet history data.
Over-Current Protectors	Over-Current Protectors history data.
Outlet	Outlets history data.
Sensor	Sensor history data.

● **File**

This page is used for downloading user manuals, mib files, etc., and requires administrator group permissions.

Mib file download:

See: [6.USING SNMP > 6.4 DOWNLOAD THE MIB FILE](#) .

● **View Event Log**

This page is used to view event logs generated by user actions, device status, or changes in environmental conditions.

Download event log:

Event log message list

Selected event type

[Download](#)

Index	Date/Time	Type	Message
2215	2018/08/11,08:29:35.644	Power	Outlet "Outlet 01"[01] recovered from a Status Summary alert -- status = Current Normal
2214	2018/08/11,08:29:35.521	Outlet Control	ON requested for outlet 'Outlet 01'[01] by FrontPanel
2213	2018/08/11,08:29:30.848	Power	Outlet "Outlet 01"[01] recovered from a Status Summary alert -- status = Relay Opened
2212	2018/08/11,08:29:30.706	Outlet Control	OFF requested for outlet 'Outlet 01'[01] by FrontPanel
2211	2018/08/11,07:56:51.517	Power	Outlet "Outlet 22"[22] recovered from a Voltage alert -- status = Normal, load value = 240.4
2210	2018/08/11,07:56:51.516	Power	Outlet "Outlet 19"[19] recovered from a Voltage alert -- status = Normal, load value = 240.4
2209	2018/08/11,07:56:43.275	Power	Outlet "Outlet 06"[06] recovered from a Voltage alert -- status = Normal, load value = 240.4
2208	2018/08/11,07:56:43.275	Power	Outlet "Outlet 03"[03] recovered from a Voltage alert -- status = Normal, load value = 240.4
2207	2018/08/11,07:55:47.981	Power	Outlet "Outlet 18"[18] recovered from a Voltage alert -- status = Normal, load value = 240.4
2206	2018/08/11,07:55:47.665	Power	Outlet "Outlet 15"[15] recovered from a Voltage alert -- status = Normal, load value = 240.4
2205	2018/08/11,07:51:48.309	Power	Phase "L-N"[P1] recovered from a Status Summary alert -- status = Normal
2204	2018/08/11,07:51:48.308	Power	Phase "L-N"[P1] recovered from a Voltage alert -- status = Normal, load value = 240.4
2203	2018/08/11,07:51:40.581	Power	Outlet "Outlet 07"[07] recovered from a Voltage alert -- status = Normal, load value = 240.4
2202	2018/08/11,07:51:19.473	Power	Outlet "Outlet 24"[24] recovered from a Voltage alert -- status = Normal, load value = 240.4
2201	2018/08/11,07:51:19.473	Power	Outlet "Outlet 21"[21] recovered from a Voltage alert -- status = Normal, load value = 240.4

Display from 1 to 15, total 2190 items, items per page. « < 1 2 3 4 5 > »

1. Choose maintenance > View Event Log.
2. Choose selected event type.
3. Click the Download button to select the file storage location.
4. Selected event type optional values in the following fields.

Field	Description
all	All event types
Access	Access events, web and CLI login, logout, timeout, etc.
Config	Configure events, network configuration, name modification, threshold configuration, configuration backup, configuration recovery, etc.
Outlet Control	Outlet control event, on, off, cycle, lock
User Administration	User management events, user additions and subtractions, editing, changing passwords
Device	Device event, device startup, network connection
System	System events, system updates, file downloads
Power	Power event, power value or sensor value exceeds the threshold, or resumes normal events
Sensor	Sensor event

- **Restart**
The device restarts Requires administrator group permissions.
Restart:

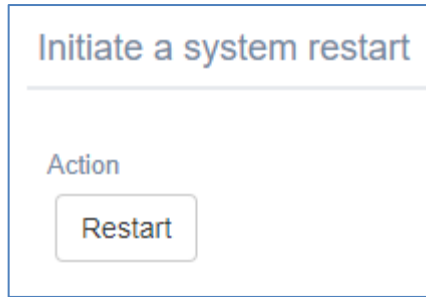

1. Choose Maintenance > Restart > Restart button.
2. Select Yes on the "Confirm." page.
3. Wait for the device to restart.

5. Using the Command Line Interface (CLI)

5.1 About the CLI

The Gelu Smart PDU provides a command line interface. you can manage, view or monitor Gelu Smart PDUs through commands. For example, you can view basic PDU information, electrical parameter information, network information, and other PDU or network settings.

There are two ways to manage Gelu Smart PDU through the command line:

The user can use the RS-232 serial cable to access the Gelu Smart PDU through the RJ45 socket marked "Console" on the device; Users can also manage the Gelu Smart PDU by remotely logging in to the command line interface via SSH.

The advantage of managing Gelu Smart PDUs through the command line interface is that users can send commands to the command line interface through scripts for automated management, while also saving user management time.

5.2 Logging in to CLI

To log in using HyperTerminal:

1. Connect your computer to the Gelu Smart PDU via RS-232 serial cable;
2. Launch HyperTerminal on your computer and make sure the COM port settings use this configuration:
 - Baud rate= 115200(115.2Kbps)
 - Data bits = 8
 - Stop bits = 1
 - Parity = None
 - Flow control = None
3. Press enter, enter the Gelu command line login interface.

To log in using SSH:

1. Connect your computer to the Gelu Smart PDU via a network cable;
2. Launch HyperTerminal on your computer;
3. Type SSH <IP>;
4. Press Enter, enter the Gelu command line login interface.

the Gelu command line login interface:

```
Login for GeluPDU CLI (192.168.10.127)
Username:admin
Password:|
```

1. Type a username: admin (default)
2. Type a password: gelupower (default)
3. Press Enter.

After successful login, the interface is displayed as follows:

```
welcome to GeluPDU CLI.  
Type 'help' at any time to get help.  
-----  
#
```

5.3 about different CLI Modes and Prompts

Depending on the login name you use and the mode you enter, the system prompt in the CLI varies. there are 3 modes as follows:

User Mode: When you log in as a normal user, who may not have full permissions to configure the PDU device, the ">" prompt appears;

Administrator Mode: When you log in as an administrator, who has full permissions to configure the PDU device, the # prompt appears;

Configuration Mode: You can enter the configuration mode from the administrator. In this mode, the prompt changes to "config: #" and you can change PDU device and network configurations;

5.4 Common command

- **Help**

If you are not sure what commands or parameters are available for a particular type of CLI command or its syntax, you can have the CLI show them by adding a space and the help command (?) to the end of that command. A list of available parameters and their descriptions will be displayed.

```
>help  
>?  
#help  
#?  
config:#help  
config:#?
```

- **config**

You can type config to enter the configuration mode from the administrator. In this mode, the prompt changes to "config: #".

```
# config  
config:#
```

- **exit**

you can type 'exit' to exit CLI anytime.

```
>exit
#exit
```

● **show**

This command allows you to view information such as configuration information, switch status, current, voltage, power, power usage, system time, system version, network configuration, and service enable status.

command	description
<p>show [argument] for example: #show pdu</p>	<p>Show system information [argument]:</p> <ul style="list-style-type: none"> • pdu – shows the PDU information. • inlets <n> – shows the inlet <n> information. • ocp <n> – show current or on/off of the ocp <n>. • outlets <n> – show status,electrical parameters, configuration, and socket type of the outlet <n>. • externalsensors <n> – shows the external sensors(such as temperature and humidity sensor) <n> information. • network – shows the network information. • time – shows the device time. • user <username> – shows the user <username> information.

● **Outlets**

This command allows you to turn on /off/cycled a single outlet or all outlets.

Command	description
<p>outlets <n/all> <on/off/cycle> for example: a) turn On all outlets # outlets all on b) power cycled outlet n # outlets 1 cycle c) turn on the first outlet</p>	<p>turn on/off/cycle outlets</p> <ul style="list-style-type: none"> • n –outlet ID • all – all outlets • on – turn on • off – turn off • cycle – power cycled

# outlets 1 on	
d) turn off the first outlet	
# outlets 1 off	

Note: if you entered the command without "/y", a message will appear, prompting you to confirm the operation.type 'y' for yes,'n' for 'no';

- **Ping**

If the network connection is not available when you operates the PDU, you can check the network connectivity through the command line ping tool.

Command	description
ping <dest> for example: # ping 192.168.10.1	check the network connectivity <ul style="list-style-type: none"> • dest – Target domain name or IP address

- **password**

Each user has permission to change their own password, you can use this command to change your own password;

your own password

Command	description
password for example: config: # password	your own password After entering password, the system will prompt for the current password, then enter the new password and Re-type the new password .

5.5 configuration command

The following configuration commands only apply to the Administrator and enter the configuration mode to take effect, see [5.4 Common command→config](#)

- **apply/cancel**

You can exit the configuration mode by entering the apply or cancel command in configuration mode. The difference is that apply saves all the changes you made in configuration mode and cancel gives up all changes.

Command	description
apply for example: config: # apply	Save the changed configuration and exit configuration mode The # prompt is displayed after pressing Enter, indicating that you are returning to administrator mode.

Command	description
cancel for example: config: # cancel	Discard changes and exit configuration mode The # prompt is displayed after pressing Enter, indicating that you are returning to administrator mode.

● **Reset**

When the device is abnormal, you can use the reset command to reboot the PDU system or restore to the factory default settings.

Reboot system

Command	description
reset for example: config: # reset	reboot the system, the outlets remains in the original state during the startup process.

restore to the factory default settings

Command	description
reset factorydefaults for example: config : # reset factorydefaults	restore to the factory default settings, the outlets remain in the original state during the startup process.

note: if you entered the command without "/y", a message will appears, prompting you to confirm the operation.type 'y' for yes,'n' for 'no';

;

● **IPv4**

The IPv4 configuration command starts with 'ipv4' and can be configured for IPv4 mode, IP address, subnet mask, gateway, DNS, etc.

Configuring IPv4 mode

Command	description
ipv4 mode <mode> for example: config : # ipv4 mode dhcp	Configuring IPv4 mode <mode> : <ul style="list-style-type: none"> • dhcp – The IPv4 configuration mode is set to DHCP • static – The IPv4 configuration mode is set to static IP address.

Configuring IPv4 address

After selecting the static IP configuration mode, you can use this command to assign a permanent IP address to the device.

Command	description
ipv4 address <ip address> for example: config: # ipv4 address 192.168.10.128	Setting the IPv4 Address <ul style="list-style-type: none"> ip address – the IP address being assigned to your device. Its range from 0.0.0.0 to 255.255.255.255.

Configuring IPv4 mask

After selecting the static IP configuration mode, you can use this command to assign a mask to the device.

Command	description
ipv4 mask <mask> for example: config : # ipv4 mask 255.255.255.0	Setting the IPv4 subnet mask <ul style="list-style-type: none"> mask – subnet mask, Its range from 0.0.0.0 to 255.255.255.255.

Configuring IPv4 gateway

After selecting the static IP configuration mode, you can use this command to assign a gateway to the device.

Command	description
ipv4 gateway <ip address> for example: config: # ipv4 gateway 192.168.10.1	Setting the IPv4 Gateway <ul style="list-style-type: none"> ip address – a gateway, Its range from 0.0.0.0 to 255.255.255.255.

Configuring IPv4 primary dns

After selecting the static IP configuration mode, you can use this command to assign a primary dns to the device.

Command	description
ipv4 primarydns <ip address> for example: config : # ipv4 primarydns 192.168.10.1	Setting the IPv4 primary dns <ul style="list-style-type: none"> ip address – primary dns, Its range from 0.0.0.0 to 255.255.255.255.

Configuring IPv4 secondary dns

After selecting the static IP configuration mode, you can use this command to assign a secondary dns to the device.

Command	description
ipv4 secondarydns <ip address> for example: config : # ipv4	Setting the IPv4 secondary dns <ul style="list-style-type: none"> ip address – secondary dns,Its range from 0.0.0.0 to 255.255.255.255.

secondarydns 192.168.10.2	
------------------------------	--

● **PDU**

The PDU configuration command starts with 'PDU'. You can use the PDU configuration command to change the settings that are applied to the entire device.

Change PDU's name

Command	description
<p>pdu name "<name>" for example: config : # pdu name "gelupdu"</p>	<p>Changing PDU's name</p> <ul style="list-style-type: none"> • name – The specified PDU name,needs quotation marks with a maximum of 32 bits ASCII characters.

● **Inlet**

The inlet configuration command starts with 'inlet'.

Changing inlet's name

Command	description
<p>Inlet <n> name "<name>" for example: config: # inlet 1 name "inletA"</p>	<p>Changing inlet's name</p> <ul style="list-style-type: none"> • n – Configuring Inlet ID, for single input device, the n is 1, and the value is 1-4 integer. • name – The specified Inlet name,needs quotation marks with a maximum of 32 bits ASCII characters.

● **OCP**

The OCP configuration command starts with 'ocp'.

Changing OCP's name

Command	description
<p>ocp <n> name "<name>" for example: config: # ocp 1 name "switches CB"</p>	<p>Changing OCP's name</p> <ul style="list-style-type: none"> • n – OCP id,its range from 1 to 60. • name – The specified ocp name,needs quotation marks with a maximum of 32 bits ASCII characters.

● **Outlet**

The outlet configuration command starts with 'outlet', It can be used to configure outlet related parameters.

Changing outlet's name

Command	description
outlet <n> name "<name>" for example: config: # outlet 1 name "Email"	Changing outlet's name <ul style="list-style-type: none"> • n – outlets id ,its range from 1 to 60; • name – The specified outlet's name,needs quotation marks with a maximum of 32 bits ASCII characters.

Changing outlet state when outlet wakeup

Command	description
outlet <n> wakeupstate <option> for example: config : # outlet 1 wakeupstate last	Changing outlet state when outlet wakeup <ul style="list-style-type: none"> • n – outlets id ,its range from 1 to 60; <option> <ul style="list-style-type: none"> • on – The state of the specified Outlet after wakeup is on; • off – The state of the specified Outlet after wakeup is off; • last – The state of the specified Outlet wakeup is the previous state before shutdown.

Changing outlet power cycled delay

Command	description
outlet <n> cycledelay <timing> for example: config : # outlet 1 cycledelay 30	Changing outlet power cycled delay <ul style="list-style-type: none"> • n – outlets id ,its range from 1 to 60; • timing – Changing outlet power cycled delay(second),its range from 0 to 3600 second

- **External sensor**

The external sensor configuration command starts with 'externalsensor' , It can be used to configure external sensor related parameters.

Changing external sensor's name

Command	description
externalsensor <n> name "<name>" for example: config : # externalsensor 1 name "TOP temp"	Changing external sensor's name <ul style="list-style-type: none"> • n – external sensor's id ,its range from 1 to 60; • name – The specified external sensor's name,needs quotation marks with a maximum of 32 bits ASCII characters.

6. Using SNMP

6.1 Enabling and Configuring SNMP

To communicate with an SNMP manager, you must enable SNMP protocols.

1. Choose Configuration > Network > SNMP, open the SNMP Settings page.

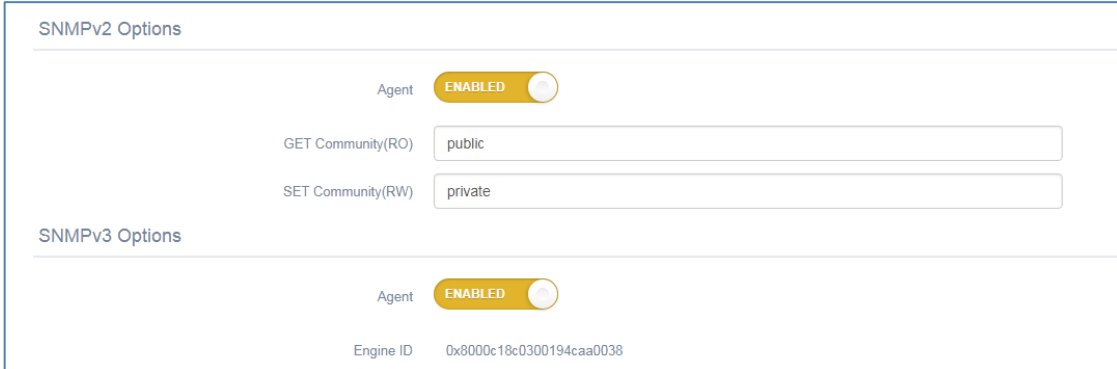

The screenshot displays the 'SNMP Settings' page, divided into two sections: 'SNMPv2 Options' and 'SNMPv3 Options'. In the 'SNMPv2 Options' section, the 'Agent' toggle is set to 'ENABLED'. Below it, the 'GET Community(RO)' field contains the text 'public', and the 'SET Community(RW)' field contains the text 'private'. The 'SNMPv3 Options' section also has its 'Agent' toggle set to 'ENABLED'. At the bottom of this section, the 'Engine ID' is listed as '0x8000c18c0300194caa0038'.

2. Select the Enable switch in the Agent (SNMP v2 Options) field to allow communication with the SNMP manager using the SNMP v1 or SNMP v2 protocol.

Enter the SNMP read-only community in the GET Community(RO) field. This string is usually "public".

Enter the read-write community in the SET Community (RW) field. This string is usually "private".

3. Select the Enable switch in the Agent (SNMP v3 Options) field to allow communication with the SNMP manager using the SNMP v3 protocol.

Note: To enable SNMP to communicate with the management platform, you must download the MIB file of the Gule PDU. For details, see ["6.4 DOWNLOAD THE MIB FILE"](#).

6.2 Configuring SNMPv3

To use the SNMPv3 protocol, you need to set the configuration.

SNMPv3 Options

Agent ENABLED

Engine ID 0x8000c18c0300194caa0038

Read-Only Username

Read-Only Access Level

Read-Only User Auth Method

Read-Only User Auth Password

Read-Only User Privacy Protocol

Read-Only User Privacy Password

Read-Write Username

Read-Write Access Level

Read-Write User Auth Method

Read-Write User Auth Password

Read-Write User Privacy Protocol

Read-Write User Privacy Password

1. Choose Configuration > Network > SNMP, open the SNMP Settings page.
2. Enter the appropriate parameters in SNMPv3 Options.
3. Click Apply to save it.

6.3 Configuring SNMP Trap

If you need Gelu PDU to send traps to the SNMP manager, you should configure the SNMP Trap configuration correctly.

Trap Options

Trap Version

Trap Format

Destination Host

v3 Username

v3 Security Level

v3 Auth Method

v3 Auth Password

v3 Privacy Protocol

v3 Privacy Password

1. Choose Configuration > Network > SNMP, open the SNMP Settings page.

2. Enter the appropriate parameters in SNMP Trap Options.
3. Click Apply to save it.

6.4 Download the MIB file

Before using the SNMP, you should download the MIB (Management Information Base) file.

Documents		
Index	File Name	Size(Byte)
0	Gelv1-MIB_20180516.mib	150133

1. Choose Maintenance > Files.
2. Click on the .mib file name to download.

Appendix A Function list of series models

The table below lists the functional differences between the different series.

Series	Smart	Smart-POM	Switched	Switched-POM	Note
Standard Spec					
Voltage		100-120VAC/200-240VAC			
Current		16A/32A/3×16A/3×32A			
Frequency		50/60Hz			
Input		Cable/IEC C20/SSEMCO 92-S3			
Output		IEC C13/IEC C19/NEMA 5-20R/GB1002 10A/GB1002 16A			
MAX Port(C13)	48	36	36	36	
Over current Protector		UL489 Circuit breaker/UL1077 breaker			
Color		Black/White			
PDU Material		Metal			
Dimension		L depends on model, 55mm(W), 60mm(D)			
Refer Standard		GB 4943.1-2011/IEC60950/UL60950			
Metered Function					
Total Current/Voltage	●	●	●	●	
Power Consumption in total in a time	●	●	●	●	
Power Consumption per phase in a time	●	●	●	●	
Power Consumption per Outlet	-	●	-	●	
Total Power and Power Factor	●	●	●	●	
Power per outlet	-	●	-	●	
Power per Bank	●	●	●	●	
Current per Bank	●	●	●	●	
Current per outlet	-	●	-	●	
(On/Off status per outlet	-	-	●	●	
Unbalance current rate(only for 3phase PDU	●	●	●	●	
Temperature/Humidity Status	●	●	●	●	
Total Power Consumption record in a time	●	●	●	●	
Phase power consumption record in a time	●	●	●	●	
Outlet power consumption record in a time	-	●	-	●	
Outlet Control					

Series	Smart	Smart-POM	Switched	Switched-POM	Note
Output On/Off control per outlet	-	-	●	●	
Outlet Group creation	-	-	●	●	
Outlet State Lock	-	-	●	●	
Outlet On/Off sequence and interval setting	-	-	●	●	
Outlet state after reset	-	-	●	●	
Alarm Setting					
Upper/Lower Limit of Input	●	●	●	●	
Upper/Lower current Limit per Bank	●	●	●	●	
Upper/Lower limit of Output per outlet	-	●	-	●	
Upper/Lower limit of temperature and humidity	●	●	●	●	
Alarm Condition					
When input beyond setting value	●	●	●	●	
When current per bank beyond setting value	●	●	●	●	
When output per bank beyond setting value	-	●	-	●	
When unbalance current rate beyond setting value	●	●	●	●	
When temperature/humidity value beyone setting value	●	●	●	●	
Alarm Way					
Local Control Panel	○	○	○	○	
Beep Alarm	○	○	○	○	
Web	●	●	●	●	
E-mail to Administrator	●	●	●	●	
SNMP Trap	●	●	●	●	
Local Alarm terminal	○	○	○	○	
Log					
User operation history	●	●	●	●	
System event reocrd	●	●	●	●	
History Record(Total current, voltage,energy,temperature/humidity)	●	●	●	●	
power info query	●	●	●	●	

Series	Smart	Smart-POM	Switched	Switched-POM	Note
User and access					
Create/edit user	●	●	●	●	
Delete user	●	●	●	●	
User priority setting	●	●	●	●	
Outlet grant setting	●	●	●	●	
Web access to control	●	●	●	●	
SNMP (v1/v2C/v3)	●	●	●	●	
Access by RS-485	○	○	○	○	
Access by console	●	●	●	●	
Cascade support, Daisy chain, 8units Max	●	●	●	●	
Accessory and sensor					
Terminal1 1-wire temperature sensor	●	●	●	●	
Terminal1 I2C temperature/humidity sensor	●	●	●	●	
Terminal2 1-wire temperature sensor	●	●	●	●	
Terminal2 I2C temperature/humidity sensor	●	●	●	●	
USB WIFI	-	-	-	-	
System					
Linux operation system	●	●	●	●	
Multi user operation system	●	●	●	●	
Web CH/EN Language	●	●	●	●	
Firmware upgrade by Web	●	●	●	●	
Reboot by Web	●	●	●	●	
Reset by local	●	●	●	●	
Abnormal connection indication in local display	○	○	○	○	
Time(Time zone) setting and display	●	●	●	●	
PDU/POSITION/Inlet/OCP/Outlet/Temperature/Humidity name setting	●	●	●	●	
Local outlet grant access setting	-	-	○	○	
Time don't reposition when PDU off	●	●	●	●	

Series	Smart	Smart-POM	Switched	Switched-POM	Note
Interface					
Ethernet Port	RJ45×1	RJ45×1	RJ45×1	RJ45×1	
EX-OUT port	RJ45×1	RJ45×1	RJ45×1	RJ45×1	
Console port	RJ45×1	RJ45×1	RJ45×1	RJ45×1	
RS-485 port	○	○	○	○	RJ45 optional
USB port	USB-A×1	USB-A×1	USB-A×1	USB-A×1	
Temperature/Humidity port	RJ45×2	RJ45×2	RJ45×2	RJ45×2	
Alarm Signal port	○	○	○	○	RJ11 optional
Detachable monitor modular	○	○	○	○	
LCD display	○	○	○	○	
First setting screen(IP address, time)	○	○	○	○	
Boot screen	○	○	○	○	
Phase current display	○	○	○	○	
Phase voltage display	○	○	○	○	
Frequence display	○	○	○	○	
Apparent power	○	○	○	○	
Active power	○	○	○	○	
Phase power metered	○	○	○	○	
Power factor	○	○	○	○	
Temperature/Humidity info	○	○	○	○	
Configuration setting(Time,screen sleep etc)	○	○	○	○	
PDU model info(IP, model, SN etc)	○	○	○	○	
Local operation button	○	○	○	○	
RESET button	Hidden	Hidden	Hidden	Hidden	
Engineering Maintenance button	Hidden	Hidden	Hidden	Hidden	

Remark: “●” Standard ; “-” N/A ; “○” Optional ;

Appendix B CLI common command summary

Show command:

Command line interface command	Description
<code>show externalsensors <n></code>	Show external sensor information
<code>show network</code>	Show network information
<code>show ocp <n></code>	Show OCP information
<code>show outlets <n></code>	Show outlet information
<code>show pdu</code>	Show PDU Basic information
<code>show time</code>	Show Date/time
<code>show user <user_name></code>	Show user information

Configuration command:

Command line interface command	Description
<code>externalsensor</code>	Configuring an external sensor
<code>inlet</code>	Configuring Inlet
<code>ipv4</code>	Configuring IPv4
<code>ocp</code>	Configuring OCP
<code>outlet <n> cycledelay <timing></code>	Configuring off time of the Outlet restart
<code>outlet <n> name "<name>"</code>	Naming the outlet name
<code>outlet <n> wakeupstate <option></code>	Configuring Outlet wakeup state
<code>pdu name "<name>"</code>	Naming the PDU name
<code>reset</code>	Reset
<code>reset factorydefaults</code>	Restore factory defaults

Other commands

Command line interface command	Description
<code>outlets</code>	Outlet on/off control
<code>ping <host></code>	Ping
<code>password</code>	Change password
<code>help</code> 或 <code>?</code>	Help

Appendix C Specification

C.1 Operating environment

This series of PDUs is suitable for the following operating environments;

Item	Range	Note
Temperature	0 - 40°C/32 - 104°F	Applicable with LCD display operating model
Temperature	0 - 50°C/32 - 122°F	Applicable without LCD display operating model
Humidity	15 - 85%RH Non-condensing	-
Elevation	0 - 2000m/6000ft	Above this height, the circuit breaker needs to be derated.

C.2 Measurement accuracy specification

Power measurement accuracy

Item	Accuracy	Range
Voltage (V)	±1%	Nominal voltage±10%
Current (A)	±1%	100mA Above
Frequency (Hz)	±1%	47 - 63Hz
Active power (W)	±1%	20W Above
Apparent power (VA)	±1%	20VA Above
Active energy (Wh)	±1%	100Wh Above

Environmental measurement accuracy

Accuracy	Accuracy	Range
Temperature (°C)	±0.5°C	-10 - 70°C
Humidity (%RH)	±3%RH	0 - 100%RH

C.3 Port Pinouts

Console(RJ-45) Port Pinouts

Port Type	Pin	Signal	Description	Note
Console (RJ-45)	1	RTS	Request To Send	Cisco# 72-3383-01 is available
	2	NC	-	
	3	TXD	Transmit Data	
	4	GND	Signal Ground	

5	GND	Signal Ground
6	RXD	Received Data
7	NC	-
8	CTS	Clear to Send

RS-485(RJ-45) Port Pinouts

Port Type	Pin	Signal	Description	Note
RS-485 (RJ-45)	1	+12V	Output +12V	
	2	NC	-	
	3	NC	-	
	4	RS485_DP	Data Positive of the RS-485 bus	
	5	RS485_DN	Data Negative of the RS-485 bus	
	6	GND	Signal Ground	
	7	NC	-	
	8	+5V	Output +5V	

Alarm(RJ-11) Port Pinouts

Port Type	Pin	Signal	Description	Note
Alarm (RJ-11)	1	RELAY-1	Relay contact 1	
	2	RELAY-1	Relay contact 1	
	3	RELAY-2	Relay contact 2	
	4	RELAY-2	Relay contact 2	

Document release history

The following table lists the issue history and confirmers of this document.

No.	Rev	Date	Release	Confirm
1	1.0	2018/10/26	Initial release	Vinter
2				
3				
4				
5				